

CRG30 RGB WELL LIGHT



INSTALLATION GUIDE

ABBA LIGHTING USA

CRG30 RGB WELL LIGHT



HEAVY DUTY CAST ALUMINUM BODY

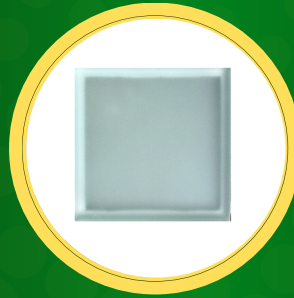

WHITE FROSTED TEMPERED GLASS



36.4 LUMENS



TRAFFIC RATED FEATURE



REQUIRES DMX CONTROLLER

CRG30 RGB WELL LIGHT

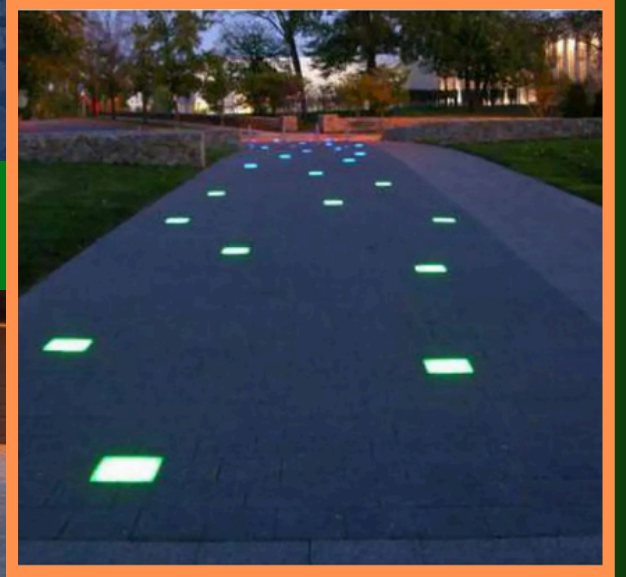

Thank you for choosing our high-quality product. To ensure the best possible experience, please take a moment to carefully read and follow all instructions before assembly, installation, and use. Doing so will not only guarantee proper function and safety but also help you maximize the full potential of this exceptional product. We truly appreciate your business and are honored to be your trusted provider of top-notch products!



YOUTUBE VIDEO
INSTALLATION GUIDE



WEBSITE



CATALOG



(800) 360-2960



ABBALightingUSA@gmail.com



7701 Alabama Ave, Canoga Park, CA 91304

WARNING

TO REDUCE THE RISK OF FIRE OR INJURY TO PERSONS:

- ✓ Please exercise caution when using the lamp, as it tends to HEAT up rapidly. We recommend taking necessary safety measures to ensure optimal usage.
- ✓ For your safety, please refrain from touching the HOT lens, guard, or enclosure. We recommend waiting for the product to cool down before handling it.
- ✓ To prevent any fire hazards, please ensure that the lamp is kept away from materials that may easily catch fire. We appreciate your cooperation in maintaining a safe and secure environment.
- ✓ For safety reasons, we recommend that only a qualified professional install this electrical product.
- ✓ Before attempting to install this unit, ensure all power connections are off for your own safety.

WARRANTY

- We stand behind the quality of our product and offer a 2 year warranty. Kindly ensure that you keep the proof of purchase as it will be required for any warranty claims.
- Warranty will be void if there is any damage due to improper usage or modification to the fixture.
- Failure to comply with the instruction in this manual may increase the risk of damage or injury and will void warranty.



YOUTUBE VIDEO
INSTALLATION GUIDE



WEBSITE



CATALOG



(800) 360-2960



ABBALightingUSA@gmail.com



7701 Alabama Ave, Canoga Park, CA 91304

CAUTION:

FIXTURE(S) MUST BE INSTALLED IN ACCORDANCE WITH ALL LOCAL CODES AND ORDINANCES.

DO NOT INSTALL WITHIN 10 FEET OF A POOL, SPA OR FOUNTAIN

PRODUCT OVERVIEW

The CRG30 RGB Brick Light is a high-performance, low-voltage RGBW LED lighting solution, designed to seamlessly blend aesthetics with functionality. Whether you're illuminating outdoor steps, pathways, or architectural walls, this durable and energy-efficient fixture delivers superior illumination while enhancing the beauty and safety of any outdoor environment. Built with high-grade aluminum, the CRG30 Brick Light is engineered to withstand harsh weather conditions, ensuring long-lasting performance.

TOOLS & MATERIALS NEEDED

Tools:

- Wire stripper
- Screwdriver
- Tape measure

Materials:

- CRG30 RGB Well light
- Electrical connectors
- Low voltage cable (for extending wiring)
- Low-voltage transformer (for low-voltage systems)



YOUTUBE VIDEO
INSTALLATION GUIDE



WEBSITE



CATALOG



(800) 360-2960



ABBALightingUSA@gmail.com



7701 Alabama Ave, Canoga Park, CA 91304

INSTALLATION GUIDE FOR CRG30 RGB

STEP-BY-STEP INSTALLATION INSTRUCTIONS

Step 1: Plan Your Layout

Determine Placement: Choose the path or area where the lights will be installed. Measure the distance between lights to ensure even illumination.

- **Consider Power Source:** Ensure that the well light can be connected to a suitable power source.
- The fixture is designed to be embedded in a brick wall, pathway, step, or similar structure.

Step 2: Check the Power Supply:

- Confirm that your 12V transformer can handle the total wattage of all connected fixtures.
- If using multiple brick lights, distribute power accordingly to avoid voltage drops.

Step 3: Prepare the Mounting Surface:

- If installing in an existing brick slot, ensure the area is clean and clear.
- If cutting into a solid surface, use a drill and masonry bit to create a mounting slot.

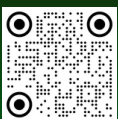

YOUTUBE VIDEO
INSTALLATION GUIDE



WEBSITE

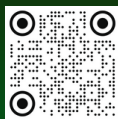

CATALOG



(800) 360-2960



ABBALightingUSA@gmail.com



7701 Alabama Ave, Canoga Park, CA 91304

INSTALLATION GUIDE FOR CRG30 RGB

1.

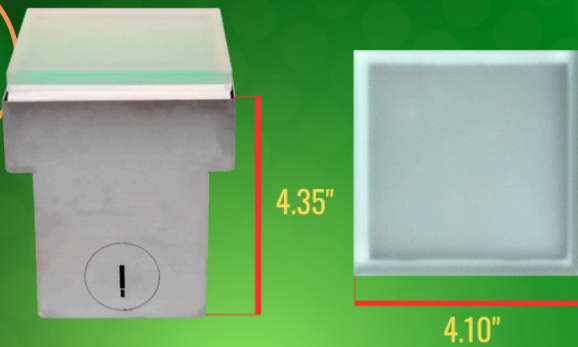

2.

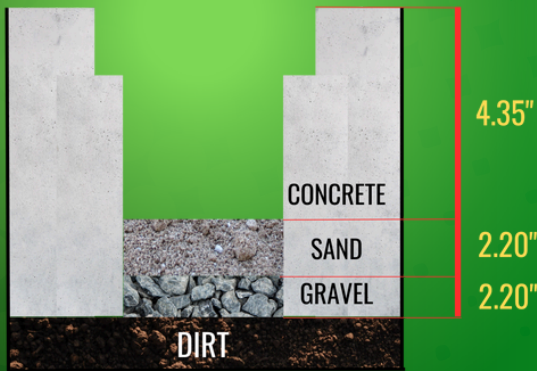
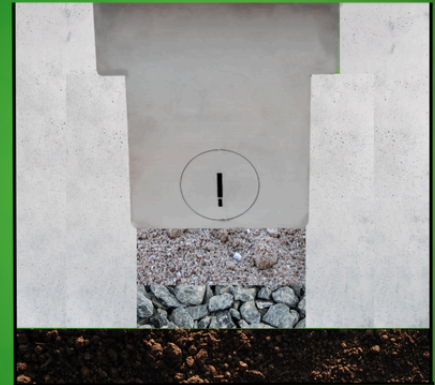

3.



4.

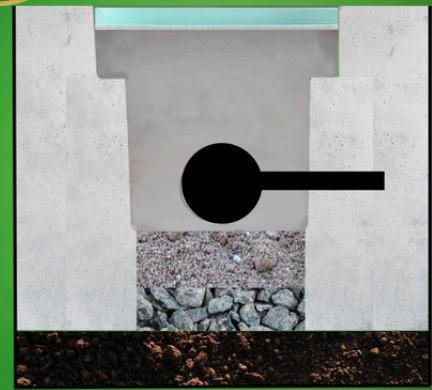

YOUTUBE VIDEO
INSTALLATION GUIDE



WEBSITE



CATALOG



(800) 360-2960



ABBALightingUSA@gmail.com







7701 Alabama Ave, Canoga Park, CA 91304

INSTALLATION GUIDE FOR CRG30 RGB

Step 4: Wiring the Fixture

Identify the Fixture Wires:

Ensure the proper connection of the wires based on their colors and use wire nuts to securely fasten the connections

-  **Brown +12VAC/DC**
-  **Blue -12VAC/DC**
-  **Red A+**
-  **White B-**
-  **White Ti-**

REQUIRES
DMX 31 12V DC 120W LED
POWER SUPPLY BRICK
LIGHT CONTROL
(SOLD SEPARATELY)



YOUTUBE VIDEO
INSTALLATION GUIDE



WEBSITE



CATALOG



(800) 360-2960



ABBALightingUSA@gmail.com



7701 Alabama Ave, Canoga Park, CA 91304

INSTALLATION GUIDE FOR CRG30 RGB

Step 5: Final Light Check

- **Power On:** Once everything is connected, turn on the power to the fixture.
- **Check Illumination:** Verify that the light is functioning properly and provides adequate illumination for the area..
- **After setup is complete, you can easily adjust the color temperature to match your preferences.**

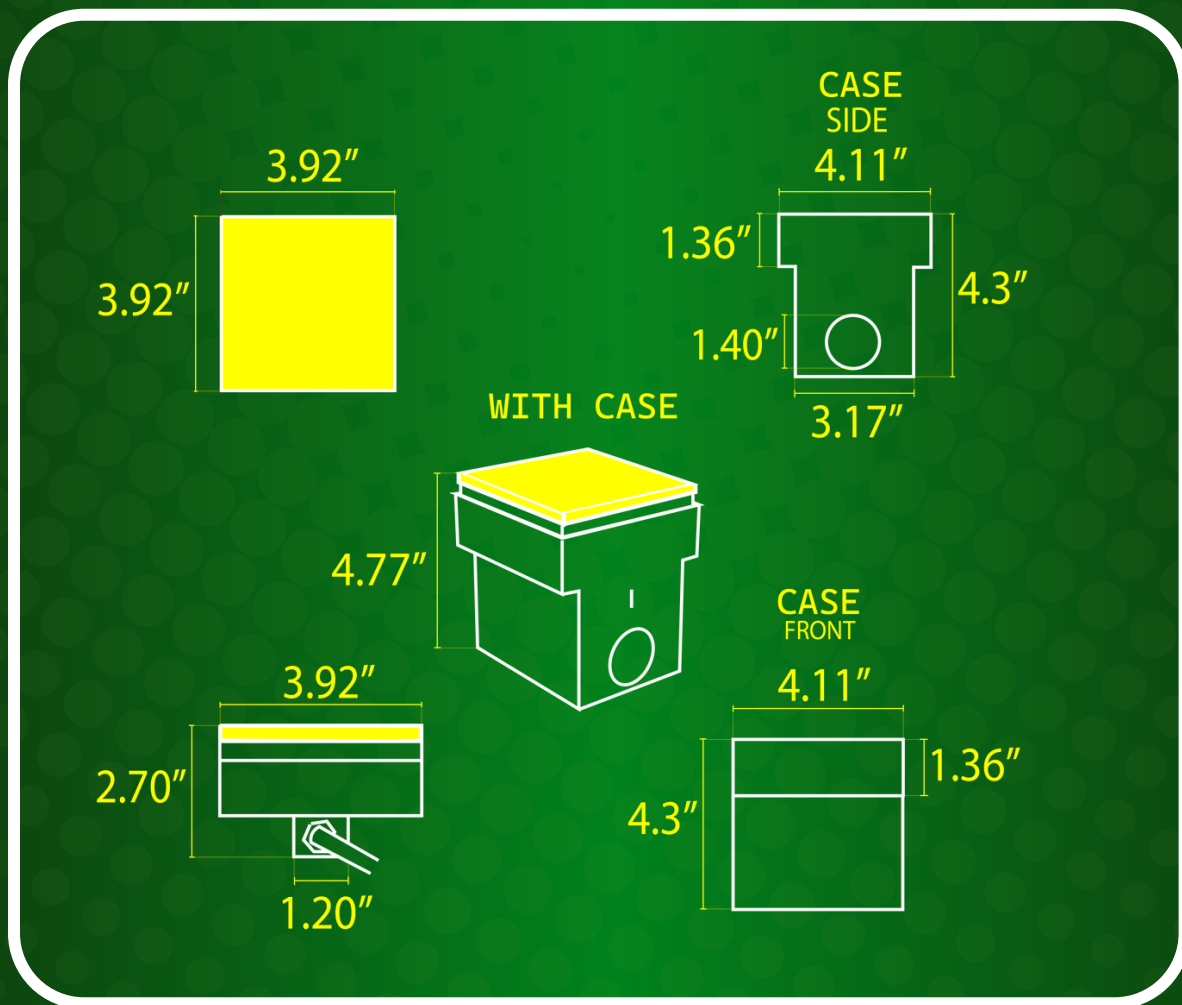

YOUTUBE VIDEO
INSTALLATION GUIDE



WEBSITE

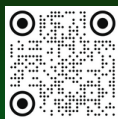

CATALOG



(800) 360-2960



ABBALightingUSA@gmail.com



7701 Alabama Ave, Canoga Park, CA 91304

INSTALLATION GUIDE FOR CRG30 RGB

MAINTENANCE TIPS

- **Regular Inspection:** Periodically check the bracket and fixture to ensure they are still securely mounted and functioning correctly.

SAFETY PRECAUTIONS

- Always wear appropriate safety gear, such as gloves and safety glasses, during installation.
- Ensure the mounting surface is capable of supporting the weight of both the bracket and the lighting fixture.

ADDITIONAL RESOURCES

For a detailed video tutorial on how to install, visit our YouTube channel and search for "**CRG30 RGB**"

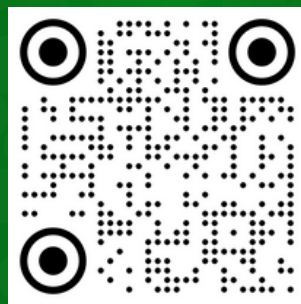

Please visit our website for more of our products.

www.ABBALightingUSA.com



YOUTUBE VIDEO
INSTALLATION GUIDE



WEBSITE



CATALOG



(800) 360-2960



ABBALightingUSA@gmail.com



7701 Alabama Ave, Canoga Park, CA 91304

CRG30 RGB

WELL LIGHT

