

CDPA74

PATH LIGHT

INSTALLATION GUIDE

ABBA LIGHTING USA

CDPA74

PATH LIGHT

700
LUMENS

7W AC/DC
12 LED

90°
BEAM
ANGLE

HEAVY DUTY
CAST ALUMINUM

BLACK FINISH



ABBA LIGHTING USA

Thank you for choosing our high-quality product. To ensure the best possible experience, please take a moment to carefully read and follow all instructions before assembly, installation, and use. Doing so will not only guarantee proper function and safety but also help you maximize the full potential of this exceptional product. We truly appreciate your business and are honored to be your trusted provider of top-notch products!

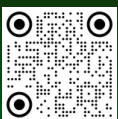

YOUTUBE VIDEO
INSTALLATION GUIDE



WEBSITE



CATALOG



(800) 360-2960



ABBALightingUSA@gmail.com



7701 Alabama Ave, Canoga Park, CA 91304

WARNING

TO REDUCE THE RISK OF FIRE OR INJURY TO PERSONS:

- ✓ Please exercise caution when using the lamp, as it tends to HEAT up rapidly. We recommend taking necessary safety measures to ensure optimal usage.
- ✓ For your safety, please refrain from touching the HOT lens, guard, or enclosure. We recommend waiting for the product to cool down before handling it.
- ✓ To prevent any fire hazards, please ensure that the lamp is kept away from materials that may easily catch fire. We appreciate your cooperation in maintaining a safe and secure environment.
- ✓ For safety reasons, we recommend that only a qualified professional install this electrical product.
- ✓ Before attempting to install this unit, ensure all power connections are off for your own safety.

WARRANTY

- We stand behind the quality of our product and offer a 2 Year warranty. Kindly ensure that you keep the proof of purchase as it will be required for any warranty claims.
- Warranty will be void if there is any damage due to improper usage or modification to the fixture.
- Failure to comply with the instruction in this manual may increase the risk of damage or injury and will void warranty.

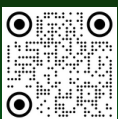

YOUTUBE VIDEO
INSTALLATION GUIDE



WEBSITE

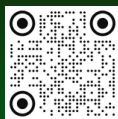

CATALOG



(800) 360-2960



ABBALightingUSA@gmail.com



7701 Alabama Ave, Canoga Park, CA 91304

CAUTION:

FIXTURE(S) MUST BE INSTALLED IN ACCORDANCE WITH ALL LOCAL CODES AND ORDINANCES.

DO NOT INSTALL WITHIN 10 FEET OF A POOL, SPA OR FOUNTAIN

PRODUCT OVERVIEW

Illuminate your outdoor spaces with the CDPA74 Integrated Aluminum Path Light, a top-tier lighting solution designed for both aesthetic appeal and practical functionality. With its sleek modern design, durable construction, and energy-efficient performance, this path light is the ideal choice for walkways, gardens, patios, and landscapes. Built to withstand the elements while providing soft, evenly distributed illumination, the CDPA74 enhances the beauty and safety of any outdoor environment.

KEY FEATURES & BENEFITS

Premium Aluminum Construction for Long-Lasting Durability

Crafted from high-quality aluminum, the CDPA74 is built to endure harsh outdoor conditions. Its corrosion-resistant, weatherproof design ensures long-term reliability against rain, snow, and UV exposure, maintaining its sleek appearance for years to come.

Integrated LED for Energy-Efficient, High-Quality Illumination

The built-in LED module delivers consistent, warm illumination, creating a welcoming ambiance while enhancing visibility and safety. Unlike traditional bulbs, this integrated LED offers:

- ✓ Long lifespan – Enjoy years of maintenance-free lighting
- ✓ Energy efficiency – Uses minimal power while providing optimal brightness
- ✓ No bulb replacements – A hassle-free lighting solution



YOUTUBE VIDEO
INSTALLATION GUIDE



WEBSITE

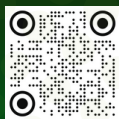

CATALOG



(800) 360-2960



ABBALightingUSA@gmail.com



7701 Alabama Ave, Canoga Park, CA 91304

CAUTION:

FIXTURE(S) MUST BE INSTALLED IN ACCORDANCE WITH ALL LOCAL CODES AND ORDINANCES.

DO NOT INSTALL WITHIN 10 FEET OF A POOL, SPA OR FOUNTAIN

Soft, Even Light Distribution for Perfect Nighttime Ambiance

Designed to provide gentle, glare-free illumination, this path light casts a beautifully diffused glow along walkways, driveways, and landscaped areas. Whether you're enhancing safety or ambiance, the CDPA74 ensures a perfectly balanced light output for any setting.

Low-Voltage 12V System for Safe & Efficient Operation

Operating on a low-voltage 12V AC/DC system, this path light is not only energy-efficient but also safe for outdoor installations. Compatible with standard low-voltage transformers, it delivers stable and consistent illumination with minimal energy consumption.

Weather-Resistant for Year-Round Performance

Rated IP65 waterproof, the CDPA74 is designed to withstand heavy rain, dust, and extreme weather conditions. This makes it an ideal choice for outdoor applications, ensuring reliable illumination throughout all seasons.

Quick & Secure Installation

Designed for effortless setup, the CDPA74 comes with a sturdy ground stake for fast and stable mounting. Whether you're installing it along garden paths, driveways, or outdoor seating areas, this fixture allows for a seamless and professional look with minimal effort.



YOUTUBE VIDEO
INSTALLATION GUIDE



WEBSITE



CATALOG



(800) 360-2960



ABBALightingUSA@gmail.com



7701 Alabama Ave, Canoga Park, CA 91304

CAUTION:

FIXTURE(S) MUST BE INSTALLED IN ACCORDANCE WITH ALL LOCAL CODES AND ORDINANCES.

DO NOT INSTALL WITHIN 10 FEET OF A POOL, SPA OR FOUNTAIN

IDEAL APPLICATIONS

- ✓ Pathways & Walkways – Ensures safe and stylish illumination for sidewalks and entryways
- ✓ Gardens & Landscapes – Enhances outdoor spaces with a warm, ambient glow
- ✓ Driveways & Courtyards – Provides visibility and security for residential or commercial settings
- ✓ Patios & Outdoor Seating Areas – Creates a cozy and inviting atmosphere for relaxation
- ✓ Commercial & Hospitality Lighting – Perfect for hotels, resorts, and parks, delivering a high-end aesthetic
- ✓ Modern & Traditional Homes – Complements any architectural style with its sleek yet timeless design

WHY CHOOSE THE CDPA74 INTEGRATED ALUMINUM PATH LIGHT?

- ✓ Sleek & Modern Design – Enhances any outdoor setting with a stylish, contemporary look
- ✓ Durable & Weatherproof – Built to last with corrosion-resistant aluminum and an IP65 rating
- ✓ Energy-Efficient LED – Integrated LED for brighter, longer-lasting illumination
- ✓ Safe & Low Voltage – Operates on 12V AC/DC, ideal for residential and commercial outdoor lighting



YOUTUBE VIDEO
INSTALLATION GUIDE



WEBSITE



CATALOG



(800) 360-2960



ABBALightingUSA@gmail.com



7701 Alabama Ave, Canoga Park, CA 91304

CAUTION:

FIXTURE(S) MUST BE INSTALLED IN ACCORDANCE WITH ALL LOCAL CODES AND ORDINANCES.

DO NOT INSTALL WITHIN 10 FEET OF A POOL, SPA OR FOUNTAIN

- ✓ Easy Installation – Quick setup with included ground stake for stable placement
- ✓ Even, Soft Light Output – Provides beautiful and functional illumination for landscapes

TECHNICAL SPECIFICATIONS

- Material: Heavy-duty aluminum
- Voltage: 12V AC/DC (Low Voltage)
- Light Source: Integrated LED (High-Efficiency)
- Weatherproof Rating: IP65 (Water and Dust Resistant)
- Finish: Premium powder-coated finish for enhanced durability
- Installation: Comes with a strong ground stake for secure placement

IMPORTANT SAFETY INFORMATION

To ensure optimal performance and safety, always use our fixtures ONLY with a low-voltage landscape transformer. This transformer reduces the voltage from 120V to 12V, making it safe and suitable for outdoor use. Failure to follow these guidelines may result in electrical hazards or damage to the fixture.



YOUTUBE VIDEO
INSTALLATION GUIDE



WEBSITE

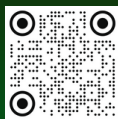

CATALOG



(800) 360-2960



ABBALightingUSA@gmail.com



7701 Alabama Ave, Canoga Park, CA 91304

INSTALLATION GUIDE FOR CDPA74

STEP-BY-STEP INSTALLATION INSTRUCTIONS

Step 1: Plan Your Layout

- **Determine Placement:** Choose the path or area where the lights will be installed. Measure the distance between lights to ensure even illumination. A typical spacing is 6–10 feet apart, depending on the desired light spread.
- **Consider Power Source:** Ensure that the Pathlight can be connected to a suitable power source. Ensure that the input voltage of the light cable wires is 12V AC/DC. Using improper voltage may cause malfunction or permanent damage to the fixture.

Step 2: Prepare the Ground

- **Dig the Hole:** Using a shovel or trowel, dig a hole where you want to install the Pathlight. The hole should be deep enough to accommodate the ground stake.
- **Ensure Stability:** Make sure the hole is wide enough to allow the ground stake to sit firmly. Test-fit the stake by inserting it into the hole to ensure stability before proceeding.

Step 3: Install the Path Light

- Insert the included ground stake securely into the ground.
- Ensure the stake is completely vertical for stability.



YOUTUBE VIDEO
INSTALLATION GUIDE



WEBSITE

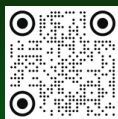

CATALOG



(800) 360-2960



ABBALightingUSA@gmail.com



7701 Alabama Ave, Canoga Park, CA 91304

INSTALLATION GUIDE FOR CDPA74

Step 4: Wire Connection Instructions

Strip the insulation: Carefully strip approximately $\frac{3}{4}$ inch (1.9 cm) of insulation from the ends of the two wires to be connected. Ensure that the exposed metal ends are clean and free of frayed strands.

Align the wires: Hold the stripped ends of both wires together, making sure they are neatly aligned with no stray strands crossing over.

Twist the wire nut: Firmly twist the wire nut clockwise onto the wires until it is tight and secure.

Insert the wires into the wire nut: Push the aligned wire ends all the way into the wire nut, ensuring that the bare metal is fully covered.

Test the connection: Gently tug on each wire to ensure they are firmly held in place and will not come loose.

Inspect the connection: Ensure that no exposed wires or loose strands are visible. If the connection is not secure, remove the wire nut and repeat the process.

⚠ **Note:** Always follow local electrical codes and regulations when performing electrical work. If unsure or uncomfortable with electrical tasks, consult a qualified electrician. Safety should always be a top priority.

Step 5: Power On & Final Adjustments

- Turn on the power to test the fixture.
- Verify proper operation before completing the installation.

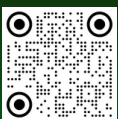

YOUTUBE VIDEO
INSTALLATION GUIDE



WEBSITE



CATALOG



(800) 360-2960



ABBALightingUSA@gmail.com



7701 Alabama Ave, Canoga Park, CA 91304

INSTALLATION GUIDE FOR CDPA74

- Bury the main cable underground for safety and protection from external elements.
- Do not exceed the maximum wattage specified for the fixture to prevent overheating or damage.
- Regularly inspect and maintain your lighting system to ensure long-term reliability.



YOUTUBE VIDEO
INSTALLATION GUIDE



WEBSITE



CATALOG



(800) 360-2960



ABBALightingUSA@gmail.com



7701 Alabama Ave, Canoga Park, CA 91304

INSTALLATION GUIDE FOR CDPA74

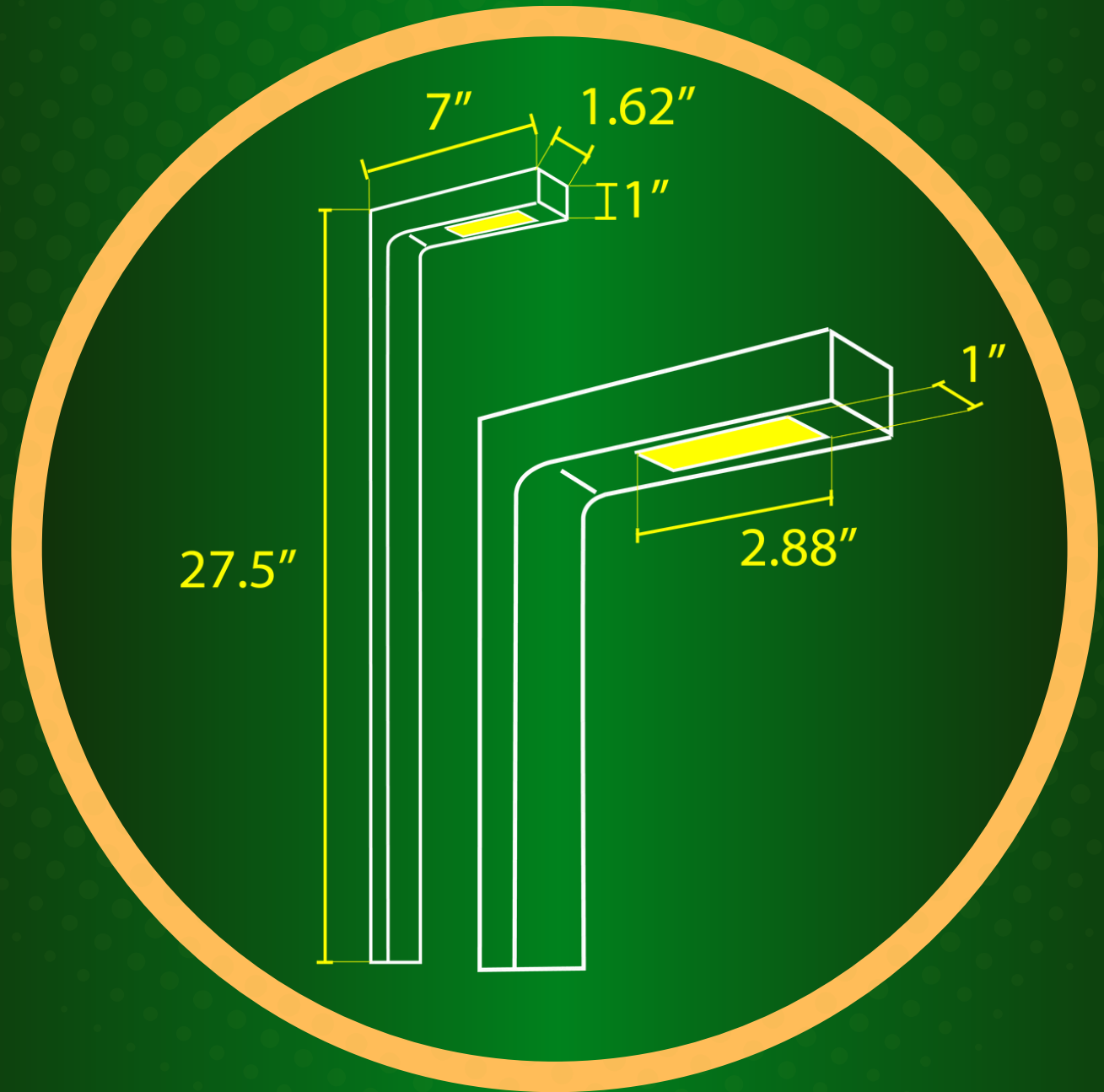

YOUTUBE VIDEO
INSTALLATION GUIDE



WEBSITE



CATALOG



(800) 360-2960



ABBALightingUSA@gmail.com



7701 Alabama Ave, Canoga Park, CA 91304

INSTALLATION GUIDE FOR CDPA74

MAINTENANCE TIPS

- **Regular Inspection:** Periodically check the bracket and fixture to ensure they are still securely mounted and functioning correctly.
- **Surface Maintenance:** Monitor the mounting surface, particularly trees, to ensure the bracket does not cause damage as the tree grows.

SAFETY PRECAUTIONS

- Always wear appropriate safety gear, such as gloves and safety glasses, during installation.
- Ensure the mounting surface is capable of supporting the weight of both the bracket and the lighting fixture.

ADDITIONAL RESOURCES

For a detailed video tutorial on how to install, visit our YouTube channel and search for "CDPA74"

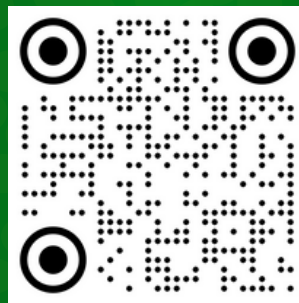

Please visit our website for more of our products.

www.ABBALightingUSA.com



YOUTUBE VIDEO
INSTALLATION GUIDE



WEBSITE

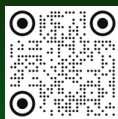

CATALOG



(800) 360-2960



ABBALightingUSA@gmail.com



7701 Alabama Ave, Canoga Park, CA 91304

CDPA74

PATH LIGHT



ABBA LIGHTING USA