

MR16 3W

LIGHT BULB

LUMENS:
270LM

POWER:
3W AC/DC
12V LED



BODY:
GLASS

TEMPERATURE:



CRI:

>80

DIMMABLE

YES

MASTER BOX:

100
PIECES

LIFE SPAN:

30,000
HOURS

BEAM ANGLE:

38°

WATERPROOF
RATING:



SPEC SHEET

SIDE ANGLE

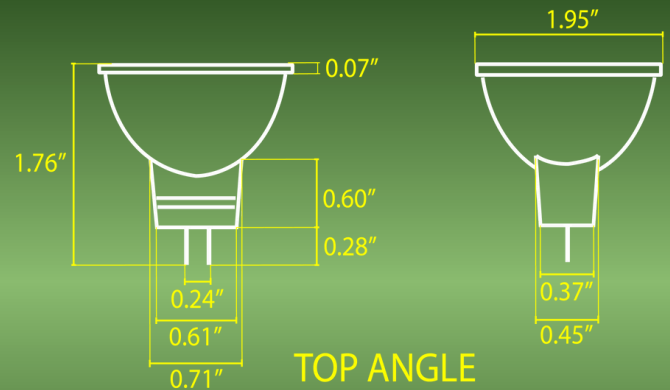

TOP ANGLE



THE MR16 3W LED BULB IS A PREMIUM LIGHTING SOLUTION DESIGNED TO DELIVER HIGH-PERFORMANCE ILLUMINATION WHILE MINIMIZING ENERGY CONSUMPTION. THIS COMPACT YET POWERFUL BULB IS THE IDEAL REPLACEMENT FOR OUTDATED HALOGEN BULBS, PROVIDING BRIGHT AND EFFICIENT LIGHTING WITH A SIGNIFICANTLY LONGER LIFESPAN. WHETHER YOU'RE ILLUMINATING YOUR HOME, UPGRADING COMMERCIAL SPACES, OR ENHANCING OUTDOOR LANDSCAPES, THIS BULB OFFERS UNMATCHED EFFICIENCY, DURABILITY, AND PERFORMANCE.

TRADITIONAL HALOGEN BULBS ARE NOTORIOUS FOR HIGH ENERGY USAGE AND FREQUENT REPLACEMENTS. WITH THE MR16 3W LED BULB, YOU GET THE SAME BRIGHTNESS AS A 25W HALOGEN BULB BUT AT A FRACTION OF THE ENERGY CONSUMPTION. THIS MEANS LOWER ELECTRICITY BILLS AND FEWER REPLACEMENTS, ULTIMATELY SAVING YOU MONEY WHILE REDUCING YOUR ENVIRONMENTAL IMPACT.



YOUTUBE VIDEO
INSTALLATION GUIDE



WEBSITE



CATALOG

ABBA

LIGHTING USA

12V Landscape Light Specialist



(800) 360-2960



ABBALightingUSA@gmail.com



7701 Alabama Ave, Canoga Park, CA 91304