

# CB04 PUCK LIGHT

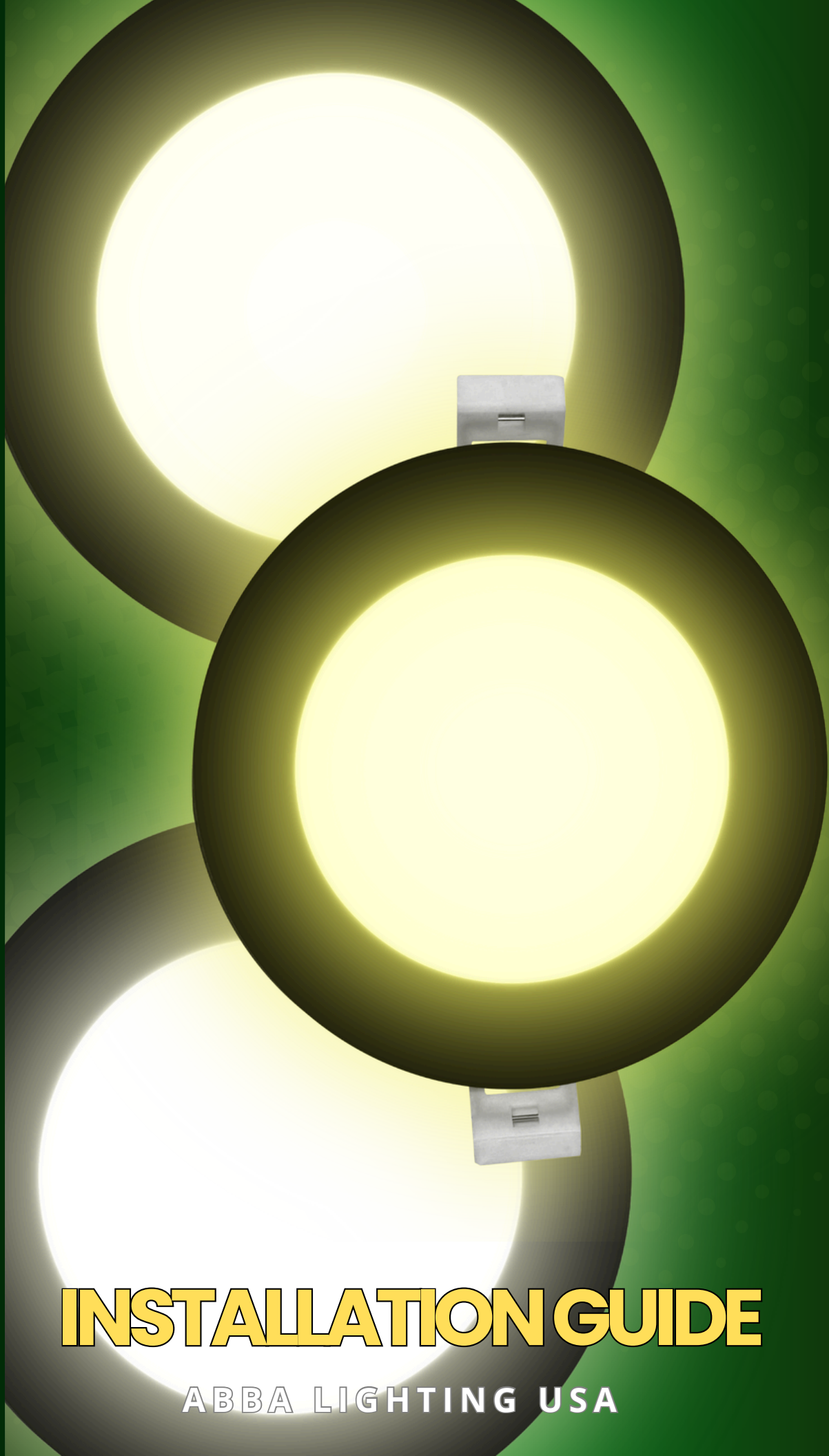

## INSTALLATION GUIDE

ABBA LIGHTING USA

# CB04 PUCK LIGHT

3000K  
WARM WHITE

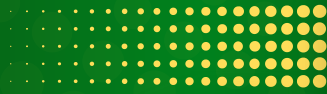

4000K  
WARM WHITE

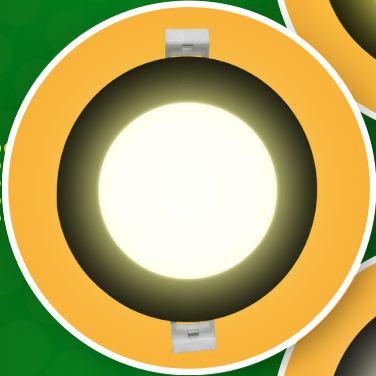
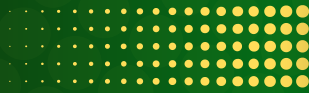

5000K  
WARM WHITE

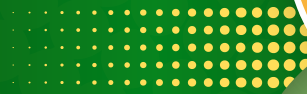

BLACK

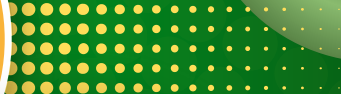

WHITE



BRUSHED NICKEL

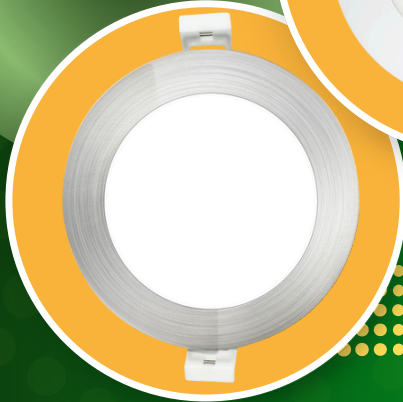
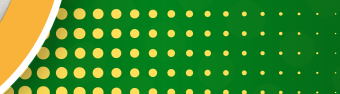

TCC3

## INSTALLATION GUIDE

ABBA LIGHTING USA

Thank you for choosing our high-quality product. To ensure the best possible experience, please take a moment to carefully read and follow all instructions before assembly, installation, and use. Doing so will not only guarantee proper function and safety but also help you maximize the full potential of this exceptional product. We truly appreciate your business and are honored to be your trusted provider of top-notch products!

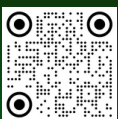

YOUTUBE VIDEO  
INSTALLATION GUIDE



WEBSITE



CATALOG



(800) 360-2960



ABBALightingUSA@gmail.com



7701 Alabama Ave, Canoga Park, CA 91304

# WARNING

## TO REDUCE THE RISK OF FIRE OR INJURY TO PERSONS:

- ✓ Please exercise caution when using the lamp, as it tends to HEAT up rapidly. We recommend taking necessary safety measures to ensure optimal usage.
- ✓ For your safety, please refrain from touching the HOT lens, guard, or enclosure. We recommend waiting for the product to cool down before handling it.
- ✓ To prevent any fire hazards, please ensure that the lamp is kept away from materials that may easily catch fire. We appreciate your cooperation in maintaining a safe and secure environment.
- ✓ For safety reasons, we recommend that only a qualified professional install this electrical product.
- ✓ Before attempting to install this unit, ensure all power connections are off for your own safety.

# WARRANTY

- We stand behind the quality of our product and offer a 2 year warranty. Kindly ensure that you keep the proof of purchase as it will be required for any warranty claims.
- Warranty will be void if there is any damage due to improper usage or modification to the fixture.
- Failure to comply with the instruction in this manual may increase the risk of damage or injury and will void warranty.

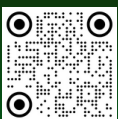

YOUTUBE VIDEO  
INSTALLATION GUIDE



WEBSITE

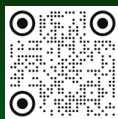

CATALOG



(800) 360-2960



ABBALightingUSA@gmail.com



7701 Alabama Ave, Canoga Park, CA 91304



# CAUTION:

**FIXTURE(S) MUST BE INSTALLED IN ACCORDANCE WITH ALL LOCAL CODES AND ORDINANCES.**

**DO NOT INSTALL WITHIN 10 FEET OF A POOL, SPA OR FOUNTAIN**

## PRODUCT OVERVIEW

The CB04-3CCT LED Driver Puck Light by ABBA Lighting USA combines sleek design, durability, and versatility. Crafted from cast aluminum with a slim profile, it offers 3 adjustable color temperatures (3000K, 4000K, 5000K) and delivers up to 900 lumens of bright illumination. Available in Black, Brushed Nickel, or White, it's perfect for residential and commercial spaces, effortlessly enhancing kitchens, hallways, offices, and more.

## TOOLS & MATERIALS NEEDED

### Tools:

- Wire stripper (if hardwired)
- Screwdriver
- Tape measure

### Materials:

- CB04 Puck Light
- Electrical connectors (for hardwiring)
- Low-voltage transformer (for low-voltage systems)
- WN12 Wire nuts (Sold Separately)

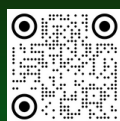

YOUTUBE VIDEO  
INSTALLATION GUIDE



WEBSITE



CATALOG



(800) 360-2960



ABBALightingUSA@gmail.com



7701 Alabama Ave, Canoga Park, CA 91304

# INSTALLATION GUIDE FOR CB04

## STEP-BY-STEP INSTALLATION INSTRUCTIONS

### Plan Your Layout

**Determine Placement:** Choose the area where the lights will be installed. Measure the distance between lights to ensure even illumination.

- **Consider Power Source:** Ensure that the Puck light can be connected to a suitable power source.

### Step 1: Preparation

- **Power Off:** Ensure the power is turned off before starting installation to avoid electrical hazards.
- **Mark the Location:** Use a pencil or marker to precisely mark the desired position for the fixture.
- **Drill the Hole:** On the marked spot, create a hole with a 4.07-inch diameter, suitable for a 4-inch panel light.

### Step 2: Wiring the Fixture

- **Strip the Wires:** Strip approximately 3/4 inch (1.9 cm) of insulation from the ends of the wires to expose clean, bare metal.
- **Align the Wires:** Neatly align the stripped ends of the two wires, ensuring no stray strands are crossing.
- **Secure with Wire Nuts:** Insert the aligned wires into a WN12 waterproof wire nut (sold separately). Twist the wire nut clockwise until it is tight and snug, covering the bare ends completely. Wrap electrical tape around the wire nut and wires for added protection.



YOUTUBE VIDEO  
INSTALLATION GUIDE



WEBSITE

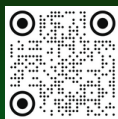

CATALOG



(800) 360-2960



ABBALightingUSA@gmail.com



7701 Alabama Ave, Canoga Park, CA 91304

# INSTALLATION GUIDE FOR CB04

- **Test the Connection:** Gently pull on each wire to confirm they are securely held by the wire nut.

## Step 3: Installing the Fixture

- **Adjust Light Temperature:** Select the desired color temperature 3000K (Warm White), 4000K (Natural White), or 5000K (Cool White).
- **Secure the Fixture:** Adjust the fixture's clips by bending them as necessary. Position the fixture over the hole and ensure it fits securely.

## Final Steps

- **Power On:** Turn the power back on via the switch controlling the fixture. Verify that the light operates correctly and the lighting effect meets your preferences.
- **Observe the Lighting:** Take a moment to enjoy the enhanced lighting experience.



YOUTUBE VIDEO  
INSTALLATION GUIDE



WEBSITE



CATALOG



(800) 360-2960



ABBALightingUSA@gmail.com



7701 Alabama Ave, Canoga Park, CA 91304

# INSTALLATION GUIDE FOR CB04



Attach the wires from the fixture(s) to the main cable, For best results, we recommend using WN12 waterproof wire nuts (which are sold separately)

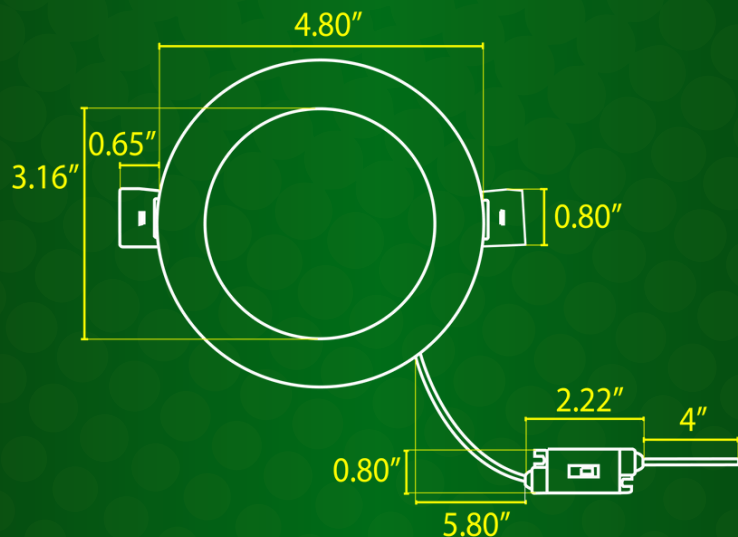

YOUTUBE VIDEO  
INSTALLATION GUIDE



WEBSITE

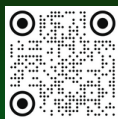

CATALOG



(800) 360-2960



ABBALightingUSA@gmail.com



7701 Alabama Ave, Canoga Park, CA 91304



# INSTALLATION GUIDE FOR CB04

## MAINTENANCE TIPS

- **Regular Inspection:** Periodically check the bracket and fixture to ensure they are still securely mounted and functioning correctly.

## SAFETY PRECAUTIONS

- Always wear appropriate safety gear, such as gloves and safety glasses, during installation.
- Ensure the mounting surface is capable of supporting the weight of both the bracket and the lighting fixture.

## ADDITIONAL RESOURCES

For a detailed video tutorial on how to install, visit our YouTube channel and search for "CB04"

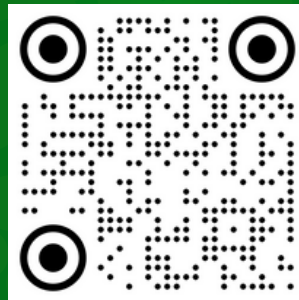

Please visit our website for more of our products.

[www.ABBALightingUSA.com](http://www.ABBALightingUSA.com)



YOUTUBE VIDEO  
INSTALLATION GUIDE



WEBSITE



CATALOG



(800) 360-2960



ABBALightingUSA@gmail.com



7701 Alabama Ave, Canoga Park, CA 91304

# CB04

PUCK LIGHT

