

CDRA-30

SPOT LIGHT



INSTALLATION GUIDE

ABBA LIGHTING USA

CDRA-30

SPOT LIGHT



ABBA LIGHTING USA

CDRA30

SPOT LIGHT



CDRA30 SPOT LIGHT

COMPATIBLE WITH



ANDROID



APPLE



REMOTE CONTROL INCLUDED



IP65

22°

35°

57°

BEAM ANGLE



HEAVY DUTY SPIKE INCLUDED

- RED - 81 LUMENS
- GREEN - 109 LUMENS
- BLUE - 22 LUMENS
- WHITE - 182 LUMENS

CDRA-30 SPOT LIGHT

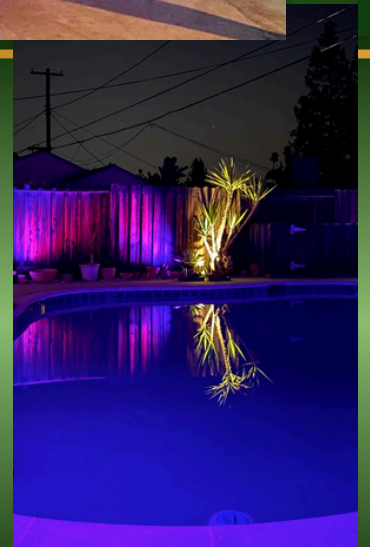

Thank you for choosing our high-quality product. To ensure the best possible experience, please take a moment to carefully read and follow all instructions before assembly, installation, and use. Doing so will not only guarantee proper function and safety but also help you maximize the full potential of this exceptional product. We truly appreciate your business and are honored to be your trusted provider of top-notch products!



YOUTUBE VIDEO
INSTALLATION GUIDE



WEBSITE



CATALOG



(800) 360-2960



ABBALightingUSA@gmail.com



7701 Alabama Ave, Canoga Park, CA 91304

WARNING

TO REDUCE THE RISK OF FIRE OR INJURY TO PERSONS:

- ✔ Please exercise caution when using the lamp, as it tends to HEAT up rapidly. We recommend taking necessary safety measures to ensure optimal usage.
- ✔ For your safety, please refrain from touching the HOT lens, guard, or enclosure. We recommend waiting for the product to cool down before handling it.
- ✔ To prevent any fire hazards, please ensure that the lamp is kept away from materials that may easily catch fire. We appreciate your cooperation in maintaining a safe and secure environment.
- ✔ For safety reasons, we recommend that only a qualified professional install this electrical product.
- ✔ Before attempting to install this unit, ensure all power connections are off for your own safety.

WARRANTY

- We stand behind the quality of our product and offer a 2 year warranty. Kindly ensure that you keep the proof of purchase as it will be required for any warranty claims.
- Warranty will be void if there is any damage due to improper usage or modification to the fixture.
- Failure to comply with the instruction in this manual may increase the risk of damage or injury and will void warranty.



YOUTUBE VIDEO
INSTALLATION GUIDE



WEBSITE



CATALOG



(800) 360-2960



ABBALightingUSA@gmail.com



7701 Alabama Ave, Canoga Park, CA 91304

CAUTION:

FIXTURE(S) MUST BE INSTALLED IN ACCORDANCE WITH ALL LOCAL CODES AND ORDINANCES.

DO NOT INSTALL WITHIN 10 FEET OF A POOL, SPA OR FOUNTAIN

PRODUCT OVERVIEW

The CDRA30-RGBW Aluminum Spot Light is the perfect blend of style, innovation, and functionality. Whether you're a homeowner transforming your backyard, a contractor looking for a high-performance solution to create an eye-catching view, this spotlight delivers unmatched quality and versatility.

Designed to endure the toughest environments, the CDRA30-RGBW is made from heavy-duty cast aluminum with a sleek black finish. Its robust construction resists wear and tear, ensuring reliable performance for years to come.

TOOLS & MATERIALS NEEDED

Tools:

- Shovel or trowel
- Wire stripper
- Screwdriver
- Tape measure

Materials:

- CDRA30 Spot Light
- Ground stake (included)
- Electrical connectors (for hardwiring)
- Low-voltage transformer (for low-voltage systems)
- WN12 Wire nuts (Sold Separately)



YOUTUBE VIDEO
INSTALLATION GUIDE



WEBSITE

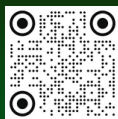

CATALOG



(800) 360-2960



ABBALightingUSA@gmail.com



7701 Alabama Ave, Canoga Park, CA 91304

INSTALLATION GUIDE FOR CDRA30

STEP-BY-STEP INSTALLATION INSTRUCTIONS

Step 1: Plan Your Layout

- **Determine Placement:** Choose the path or area where the lights will be installed. Measure the distance between lights to ensure even illumination. A typical spacing is 6–10 feet apart, depending on the desired light spread.
- **Consider Power Source:** Ensure that the path light can be connected to a suitable power source.

Step 2: Prepare the Ground

- **Dig the Hole:** Using a shovel or trowel, dig a hole where you want to install the path light. The hole should be deep enough to accommodate the ground stake.
- **Ensure Stability:** Make sure the hole is wide enough to allow the ground stake to sit firmly. Test-fit the stake by inserting it into the hole to ensure stability before proceeding.

Step 3: Connect the Electrical Wiring

- **Strip the Wires:** Use a wire stripper to strip ½ inch of insulation from the end of the light's wires.
- **Connect to the Transformer:** Attach the wires to the low-voltage transformer, . Ensure the positive and negative terminals are correctly aligned.
- **Waterproof the Connections:** Use WN12 waterproof wirenuts (Sold Separately) to protect the wiring from moisture and outdoor conditions when connecting the wires from the fixture.



YOUTUBE VIDEO
INSTALLATION GUIDE



WEBSITE

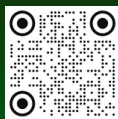

CATALOG



(800) 360-2960



ABBALightingUSA@gmail.com



7701 Alabama Ave, Canoga Park, CA 91304

INSTALLATION GUIDE FOR CDRA30

Step 4: Attach the Spot Light

- **Mount the Fixture:** Once the wiring is complete, securely attach the CDRA30 Spot light to the ground stake.
- **Secure the Fixture:** Ensure the fixture is stable and upright. Adjust the positioning as needed before tightening the fixture in place.

Step 6: Final Light Check

- **Power On:** Once everything is connected, turn on the power to the fixture.
- **Check Illumination:** Verify that the path light is functioning properly and provides adequate illumination for the area
- Once the installation is successfully completed, you can effortlessly adjust the light's color using the provided remote control. Simply aim the remote at the fixture and select your preferred color or lighting mode to create the perfect ambiance. Additionally, the remote offers four automatic modes to choose from: Flash, Strobe, Fade, and Smooth, allowing you to enhance your lighting experience with dynamic effects.



YOUTUBE VIDEO
INSTALLATION GUIDE



WEBSITE



CATALOG



(800) 360-2960



ABBALightingUSA@gmail.com



7701 Alabama Ave, Canoga Park, CA 91304

INSTALLATION GUIDE FOR CDRA30

Step 7: Pairing your phone with the ap

- Scan the QR code to download and install the HappyLighting application. For iOS devices (iPhone or iPad), access the App Store. For Android devices, download it from the Google Play Store.



- Enable Bluetooth on your Apple or Android device.
- Power on the CDRA30. Open the application, tap the button in the top-left corner to display the device list, and select the light to initiate the connection
- You can group 3 to 12 lights using the app, depending on your Android or iOS system version. To do this, tap 'Group Manage,' select the desired lights, and add them to a group. Multiple groups can be created

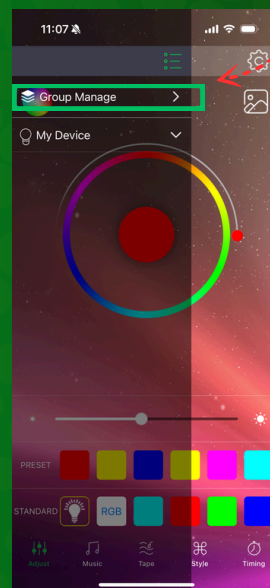
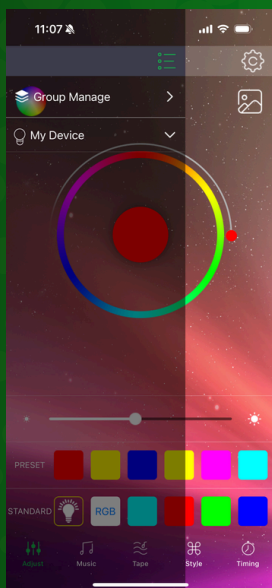

YOUTUBE VIDEO
INSTALLATION GUIDE



WEBSITE



CATALOG



(800) 360-2960



ABBALightingUSA@gmail.com



7701 Alabama Ave, Canoga Park, CA 91304

INSTALLATION GUIDE FOR CDRA30

- **RGBW mode**, where you can modify both the RGB (Red, Green, Blue) color settings and the brightness. The app includes 6 presets and 6 standard color buttons for quick access to individual channels.

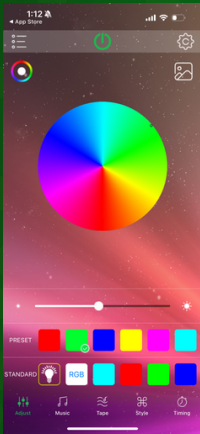

- **Tape Mode**: In this mode, the connected CDRA30 reacts to external sounds and noise levels, functioning like a microphone to light up accordingly.



- **Music Mode**: In this mode, the connected CDRA30 will synchronize with the rhythm of the music playing on your smartphone or tablet. To activate, open your music library on the device, select the desired track, and use the Pause/Play button in the center to start or stop both the music and the light fixture.

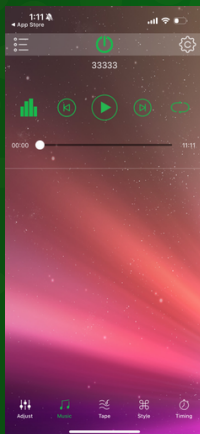

- **Style**: There are 20 preset modes available, each with adjustable speed controlled via the slider.

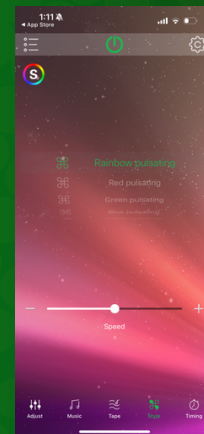

YOUTUBE VIDEO
INSTALLATION GUIDE



WEBSITE

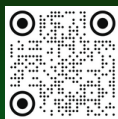

CATALOG



(800) 360-2960



ABBALightingUSA@gmail.com



7701 Alabama Ave, Canoga Park, CA 91304

INSTALLATION GUIDE FOR CDRA30

- The controller features a built-in timer function, accessible by tapping the 'Timing' button. You can set a specific ON or OFF time or configure the light to operate within a time interval. Note that the timer will not function if the power supply is interrupted.

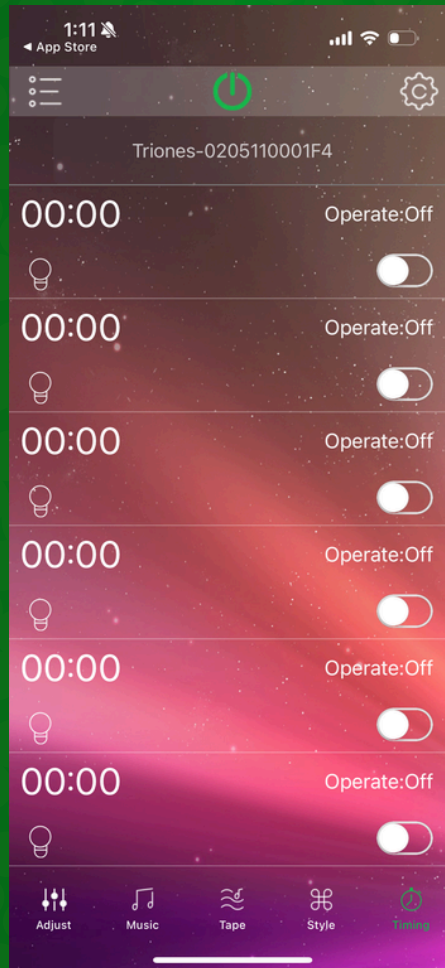

YOUTUBE VIDEO
INSTALLATION GUIDE



WEBSITE



CATALOG



(800) 360-2960



ABBALightingUSA@gmail.com



7701 Alabama Ave, Canoga Park, CA 91304

INSTALLATION GUIDE FOR CDRA30

We strongly recommend that the main cable from the transformer be buried underground for safety reasons. Additionally, please be sure to avoid exceeding the maximum wattage on the fixture(s) to prevent any damage or hazards



Connect the wires using
WN12 (Sold separately)

Main Line

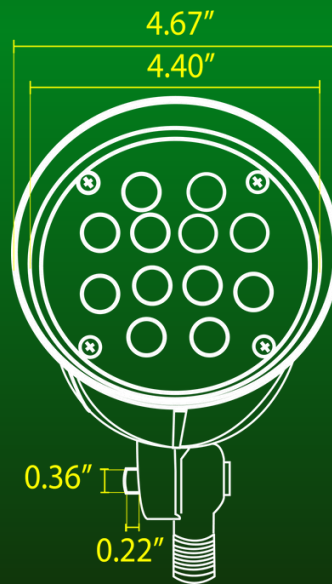
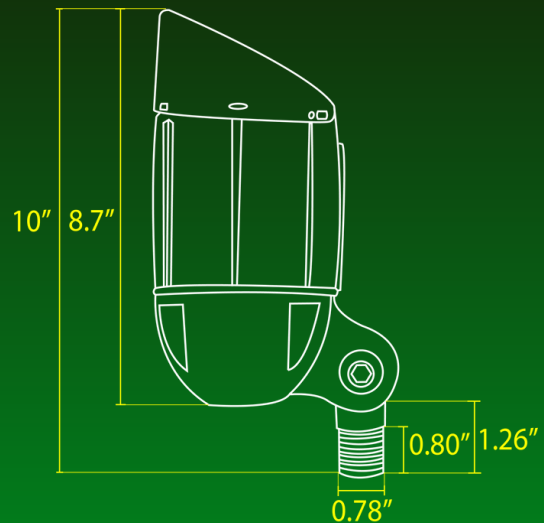

YOUTUBE VIDEO
INSTALLATION GUIDE



WEBSITE



CATALOG



(800) 360-2960



ABBALightingUSA@gmail.com



7701 Alabama Ave, Canoga Park, CA 91304

INSTALLATION GUIDE FOR CDRA30

WALL MOUNTED

Secure the outlet box cover (not included) to the outlet box using screws. Complete the branch connections as shown in the wiring diagram above. Push all wiring back into the outlet box, and thread the fixture onto the outlet box cover. Refer to the operational steps illustrated in Figures A1 and A2.

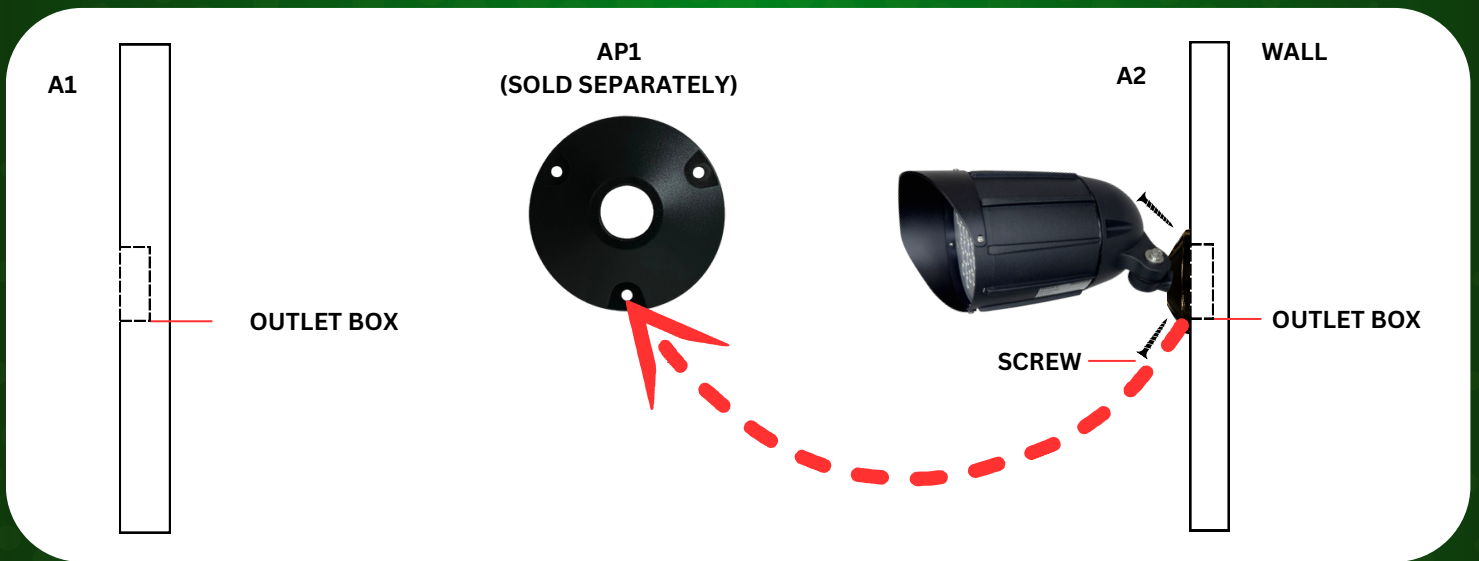

YOUTUBE VIDEO
INSTALLATION GUIDE



WEBSITE



CATALOG



(800) 360-2960



ABBALightingUSA@gmail.com



7701 Alabama Ave, Canoga Park, CA 91304

INSTALLATION GUIDE FOR CDRA30

MAINTENANCE TIPS

- **Regular Inspection:** Periodically check the bracket and fixture to ensure they are still securely mounted and functioning correctly.
- **Surface Maintenance:** Monitor the mounting surface, particularly trees, to ensure the bracket does not cause damage as the tree grows.

SAFETY PRECAUTIONS

- Always wear appropriate safety gear, such as gloves and safety glasses, during installation.
- Ensure the mounting surface is capable of supporting the weight of both the bracket and the lighting fixture.

ADDITIONAL RESOURCES

For a detailed video tutorial on how to install the **CDRA30**, visit our YouTube channel and search for "**CDRA30**"

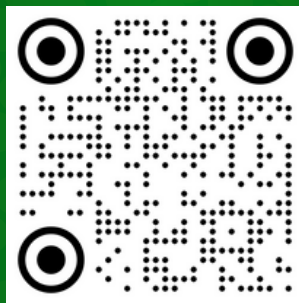

Please visit our website for more of our products.

www.ABBALightingUSA.com



YOUTUBE VIDEO
INSTALLATION GUIDE



WEBSITE



CATALOG



(800) 360-2960



ABBALightingUSA@gmail.com



7701 Alabama Ave, Canoga Park, CA 91304

CDRA30

SPOT LIGHT



ABBA LIGHTING USA