

# CB15 PUCK LIGHT

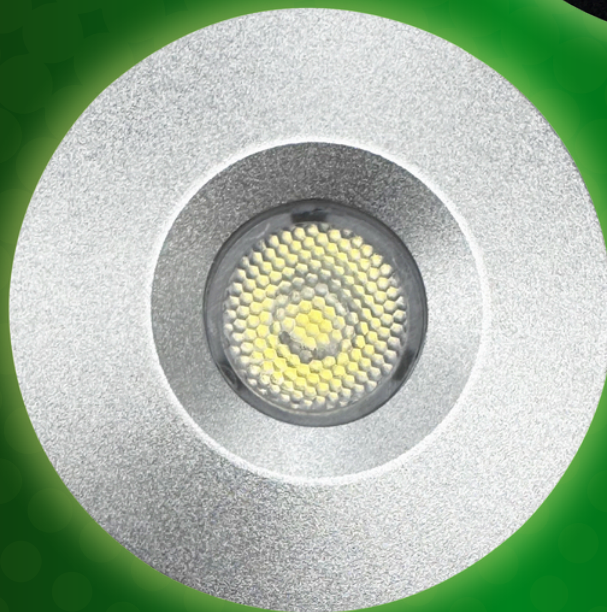
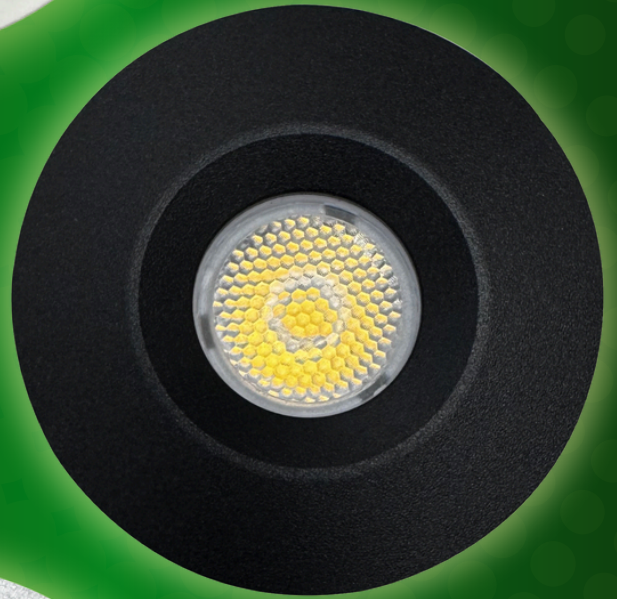
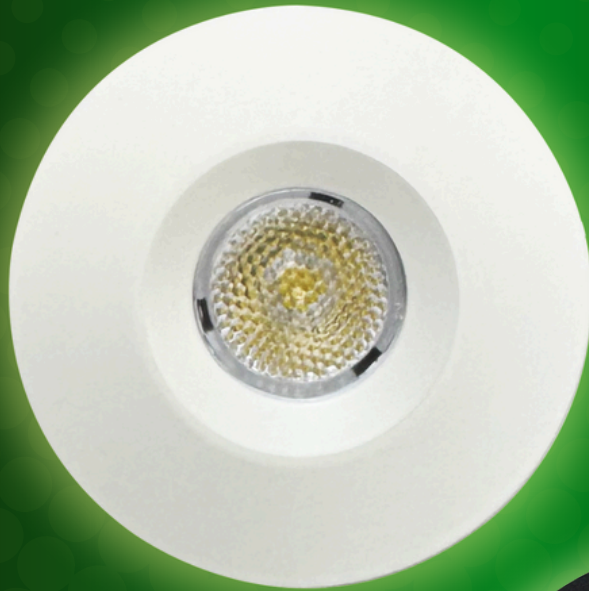

## INSTALLATION GUIDE

ABBA LIGHTING USA

# CB15 PUCK LIGHT



**SILVER**

**BLACK**

**WHITE**

**FINISH**

**3000K**

**5000K**

**TEMPERATURE**



# CB15 PUCK LIGHT

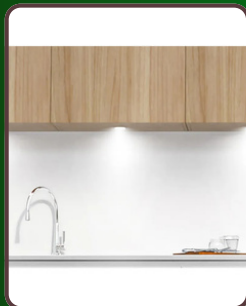

ABBA LIGHTING USA

Thank you for choosing our high-quality product. To ensure the best possible experience, please take a moment to carefully read and follow all instructions before assembly, installation, and use. Doing so will not only guarantee proper function and safety but also help you maximize the full potential of this exceptional product. We truly appreciate your business and are honored to be your trusted provider of top-notch products!



YOUTUBE VIDEO  
INSTALLATION GUIDE



WEBSITE



CATALOG



(800) 360-2960



ABBALightingUSA@gmail.com



7701 Alabama Ave, Canoga Park, CA 91304



# WARNING

## TO REDUCE THE RISK OF FIRE OR INJURY TO PERSONS:

- ✓ Please exercise caution when using the lamp, as it tends to HEAT up rapidly. We recommend taking necessary safety measures to ensure optimal usage.
- ✓ For your safety, please refrain from touching the HOT lens, guard, or enclosure. We recommend waiting for the product to cool down before handling it.
- ✓ To prevent any fire hazards, please ensure that the lamp is kept away from materials that may easily catch fire. We appreciate your cooperation in maintaining a safe and secure environment.
- ✓ For safety reasons, we recommend that only a qualified professional install this electrical product.
- ✓ Before attempting to install this unit, ensure all power connections are off for your own safety.

# WARRANTY

- We stand behind the quality of our product and offer a 2 year warranty. Kindly ensure that you keep the proof of purchase as it will be required for any warranty claims.
- Warranty will be void if there is any damage due to improper usage or modification to the fixture.
- Failure to comply with the instruction in this manual may increase the risk of damage or injury and will void warranty.



YOUTUBE VIDEO  
INSTALLATION GUIDE



WEBSITE



CATALOG



(800) 360-2960



ABBALightingUSA@gmail.com



7701 Alabama Ave, Canoga Park, CA 91304

# CAUTION:

**FIXTURE(S) MUST BE INSTALLED IN ACCORDANCE WITH ALL LOCAL CODES AND ORDINANCES.**

**DO NOT INSTALL WITHIN 10 FEET OF A POOL, SPA OR FOUNTAIN**

## PRODUCT OVERVIEW

Transform your interior spaces with the versatile and sleek CB15 Puck Cabinet Light by ABBA Lighting USA. Designed to meet the demands of homeowners & contractors, this modern lighting solution combines exceptional performance, aesthetic appeal, and energy efficiency. Whether for task lighting, accent lighting, or general illumination, the CB15 delivers dependable and beautiful results.

Outstanding Features

### Elegant Design with Superior Durability:

- The CB15 is crafted from high-quality cast aluminum, ensuring long-lasting durability and a refined appearance. Its compact and round profile, measuring 1.66 inches in diameter, provides a minimalist look that integrates seamlessly into any interior design.

### Powerful LED Illumination:

- Equipped with advanced 1.5W DC 12V COB LED technology, the CB15 delivers an impressive luminous output of 115 lumens. Its high-quality LED ensures consistent brightness and long-term energy savings, making it an eco-friendly and cost-effective solution.

### Flexible Color Temperature Options:

Achieve the perfect ambiance with two customizable color temperature options:

- Warm White (3000K): Ideal for creating a warm, cozy environment in residential spaces like living rooms and bedrooms.
- Cool White (5000K): Perfect for areas requiring crisp, bright light, such as kitchens, offices, and retail displays.

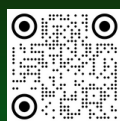

YOUTUBE VIDEO  
INSTALLATION GUIDE

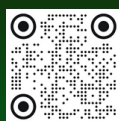

WEBSITE



CATALOG



(800) 360-2960



ABBALightingUSA@gmail.com



7701 Alabama Ave, Canoga Park, CA 91304

# CAUTION:

**FIXTURE(S) MUST BE INSTALLED IN ACCORDANCE WITH ALL LOCAL CODES AND ORDINANCES.**

**DO NOT INSTALL WITHIN 10 FEET OF A POOL, SPA OR FOUNTAIN**

## Precision Beam Angle for Focused Lighting:

- Featuring a 19° beam angle, the CB15 provides focused illumination that's perfect for accenting specific areas, highlighting key features, or task lighting where precision is essential.

## Dimmable for Versatile Use:

- Fully compatible with dimmable systems, the CB15 allows you to adjust the brightness to suit any mood or setting, offering unparalleled versatility and control.

## APPLICATIONS

The CB15 Puck Cabinet Light is a multipurpose lighting solution that enhances functionality and aesthetics across a variety of settings:

### Under-Cabinet Lighting:

- Brighten your kitchen countertops and workspaces with functional, focused lighting that enhances visibility and elevates the design of your home.

### Display and Accent Lighting:

- Showcase artwork, collectibles, or products with precision and style. The CB15 is perfect for retail environments, gallery displays, or accentuating architectural features.

### Closet and Utility Lighting:

- Light up closets, pantries, and other compact areas with its reliable and energy-efficient illumination.



YOUTUBE VIDEO  
INSTALLATION GUIDE



WEBSITE

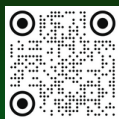

CATALOG



(800) 360-2960



ABBALightingUSA@gmail.com



7701 Alabama Ave, Canoga Park, CA 91304



# CAUTION:

**FIXTURE(S) MUST BE INSTALLED IN ACCORDANCE WITH ALL LOCAL CODES AND ORDINANCES.**

**DO NOT INSTALL WITHIN 10 FEET OF A POOL, SPA OR FOUNTAIN**

## Commercial and Residential Applications:

- Whether in restaurants, offices, or homes, the CB15 is the perfect lighting companion for adding elegance and functionality to any environment.

## TECHNICAL SPECIFICATIONS

- Material: Heavy-duty cast aluminum
- Finish Options: White, Black, Silver
- Power Consumption: 1.5W DC 12V COB LED
- Luminous Output: 115 lumens
- Beam Angle: 19°
- Color Temperatures: 3000K (Warm White) or 5000K (Cool White)
- Dimensions: Diameter: 1.66 inches
- Installation Options: Recessed or Surface-Mounted
- Dimmable: Yes

## TOOLS & MATERIALS NEEDED

### Tools:

- Wire stripper (if hardwired)
- Screwdriver
- Tape measure

### Materials:

- CB15 Puck Light
- Electrical connectors (for hardwiring)
- Low-voltage transformer (for low-voltage systems)



YOUTUBE VIDEO  
INSTALLATION GUIDE



WEBSITE



CATALOG



(800) 360-2960



ABBALightingUSA@gmail.com



7701 Alabama Ave, Canoga Park, CA 91304

# CAUTION:

**FIXTURE(S) MUST BE INSTALLED IN ACCORDANCE WITH ALL LOCAL CODES AND ORDINANCES.**

**DO NOT INSTALL WITHIN 10 FEET OF A POOL, SPA OR FOUNTAIN**

## LED Cabinet spot light series

DC12V

<b>CB15</b>		
Material: Anodized Aluminium Cutout: 35mm		Size: Ø42mm*H21mm Color: Silver, Black

### Specification

Power consumption	Power Input	Lum@3000K	Flux@1M	CRI
1.5W	DC12V	115lm	317lx	≥90

If input AC100-240V, need to add external LED driver(LD38/LD39)



### Vertical&Horizontal Beamwidth

### Center Beam Lux

	19°	Center Beam Lux			
		3000K	4000K	6000K	
0.3m		9.04cm	3674/5072LX	3332/4546LX	3681/5160LX
0.5m		18.08cm	918/1268LX	833/1136LX	920/1290LX
0.8m		27.12cm	408/563LX	370/505LX	409/573LX
1.0m		36.17cm	229/317LX	208/284LX	230/322LX
2.7m		97.65cm	31/43LX	28/38LX	31/44LX

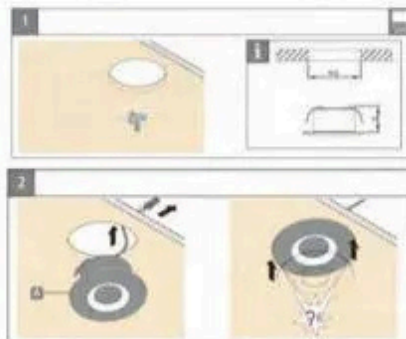

### Applications

Design for cabinet, showcase, shop area illumination

### Accessory

LED driver, cable and connector, please refer page 56,57

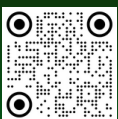

YOUTUBE VIDEO  
INSTALLATION GUIDE



WEBSITE

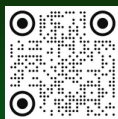

CATALOG



(800) 360-2960



ABBALightingUSA@gmail.com



7701 Alabama Ave, Canoga Park, CA 91304

# CAUTION:

FIXTURE(S) MUST BE INSTALLED IN ACCORDANCE WITH ALL LOCAL CODES AND ORDINANCES.

DO NOT INSTALL WITHIN 10 FEET OF A POOL, SPA OR FOUNTAIN

## Installation

1

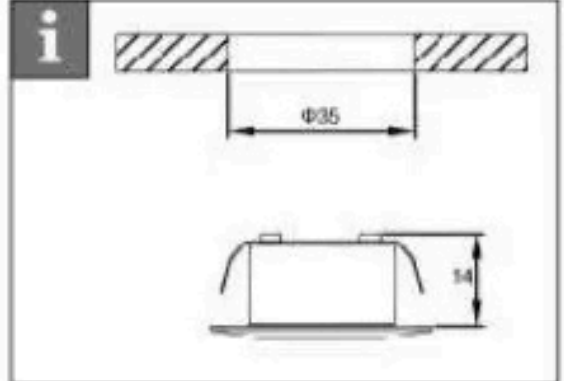

2

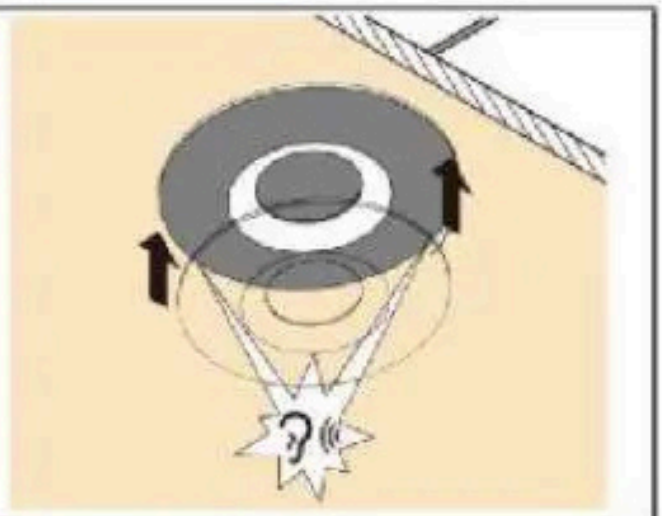
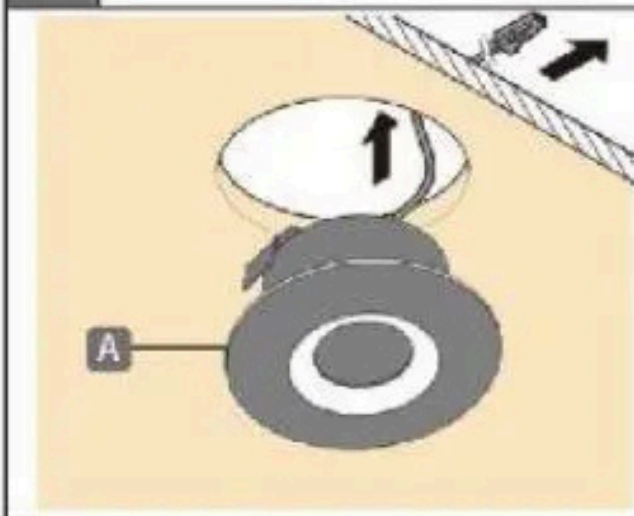

YOUTUBE VIDEO  
INSTALLATION GUIDE



WEBSITE



CATALOG



(800) 360-2960



ABBALightingUSA@gmail.com



7701 Alabama Ave, Canoga Park, CA 91304



# INSTALLATION GUIDE FOR CB15

## STEP-BY-STEP INSTALLATION INSTRUCTIONS

### Plan Your Layout

**Determine Placement:** Choose the area where the lights will be installed. Measure the distance between lights to ensure even illumination.

- **Consider Power Source:** Ensure that the Puck light can be connected to a suitable power source.

### Step 1: Preparation

- **Power Off:** Ensure the power is turned off before starting installation to avoid electrical hazards.
- **Mark the Location:** Use a pencil or marker to precisely mark the desired position for the fixture.

**Drill the Hole:** On the marked spot, create a 33mm hole and 8mm hole for the wire.

### Final Steps

- **Power On:** Turn the power back on via the switch controlling the fixture. Verify that the light operates correctly and the lighting effect meets your preferences.
- **Observe the Lighting:** Take a moment to enjoy the enhanced lighting experience.

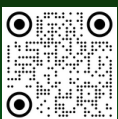

YOUTUBE VIDEO  
INSTALLATION GUIDE



WEBSITE



CATALOG



(800) 360-2960



ABBALightingUSA@gmail.com



7701 Alabama Ave, Canoga Park, CA 91304

# INSTALLATION GUIDE FOR CB15



WN12

MAIN LINE

Attach the wires from the fixture(s) to the main cable, For best results, we recommend using WN12 waterproof wire nuts (which are sold separately)

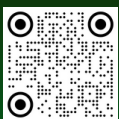
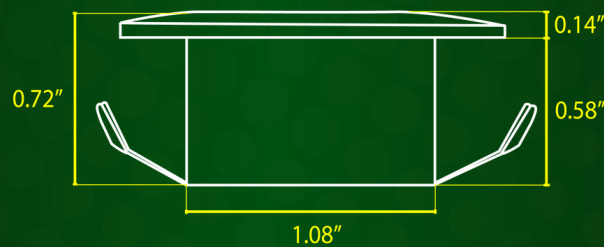
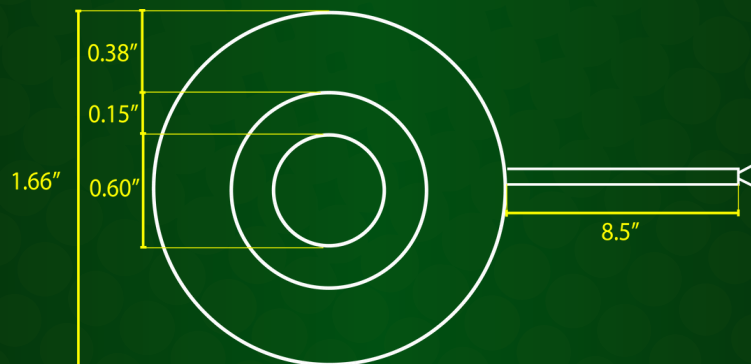

YOUTUBE VIDEO  
INSTALLATION GUIDE



WEBSITE



CATALOG



(800) 360-2960



ABBALightingUSA@gmail.com



7701 Alabama Ave, Canoga Park, CA 91304

# INSTALLATION GUIDE FOR CB15

## MAINTENANCE TIPS

- **Regular Inspection:** Periodically check the bracket and fixture to ensure they are still securely mounted and functioning correctly.

## SAFETY PRECAUTIONS

- Always wear appropriate safety gear, such as gloves and safety glasses, during installation.
- Ensure the mounting surface is capable of supporting the weight of both the bracket and the lighting fixture.

## ADDITIONAL RESOURCES

For a detailed video tutorial on how to install, visit our YouTube channel and search for "CB15"

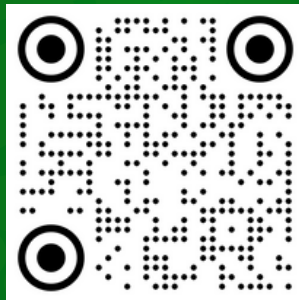

Please visit our website for more of our products.

[www.ABBALightingUSA.com](http://www.ABBALightingUSA.com)



YOUTUBE VIDEO  
INSTALLATION GUIDE



WEBSITE



CATALOG



(800) 360-2960



ABBALightingUSA@gmail.com



7701 Alabama Ave, Canoga Park, CA 91304



# CB15

PUCK LIGHT

