

# PU51

## PUC POST WITH CAP



# INSTALLATION GUIDE



PU51

(800) 360-2960  
7701 Alabama Ave.,  
Canoga Park CA, 91335  
[www.ABBALightingUSA.com](http://www.ABBALightingUSA.com)

# ABBA

**LIGHTING USA**

*12V Landscape Light Specialist*

**Congratulations on your purchase of this high-quality product! We want to ensure that you have the best possible experience with it, so we kindly ask that you take a moment to carefully read and follow all instructions before assembly, installation, and use. By doing so, you'll not only guarantee correct function and safety, but also optimize the full potential of this exceptional product. Thank you for choosing us as your trusted provider of top-notch products we truly appreciate your business!**



**YOUTUBE VIDEO  
INSTALLATION GUIDE**



**WEBSITE**

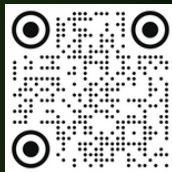

**CATALOG**

# ABBA

**LIGHTING USA**

*12V Landscape Light Specialist*

## WARNING:

### TO REDUCE THE RISK OF FIRE OR INJURY TO PERSONS:

- ✓ To prevent any fire hazards, please ensure that the lamp is kept away from materials that may easily catch fire. We appreciate your cooperation in maintaining a safe and secure environment.
- ✓ For safety reasons, we recommend that only a qualified professional install this electrical product.
- ✓ Before attempting to install this unit, ensure all power connections are off for your own safety.

## CAUTION:

**FIXTURE(S) MUST BE INSTALLED IN ACCORDANCE WITH ALL LOCAL CODES AND ORDINANCES.**

**DO NOT INSTALL WITHIN 10 FEET OF A POOL, SPA OR FOUNTAIN**

### PRODUCT OVERVIEW

The PV51 PVC Post is designed for use with landscape lighting fixtures, offering a durable and secure foundation in soft soil or sand. Made of heavy-duty PVC with a black finish, this post includes a cap and a unique “Ground Grabber” stabilizer with ribs and teeth for maximum stability. It features a 1/2" threaded hole for compatibility with most landscape lighting fixtures.



YOUTUBE VIDEO  
INSTALLATION GUIDE



WEBSITE

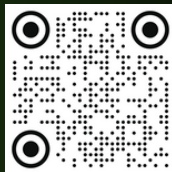

CATALOG

# ABBA

LIGHTING USA

*12V Landscape Light Specialist*

# INSTRUCTION MANUAL FOR PV51 INSTALLATION

## COMPONENTS INCLUDED

- 1x PVC Post with Cap (17.5" L x 3" W)
- Stabilizer Teeth and Ribs

## STEP-BY-STEP INSTALLATION INSTRUCTIONS

### 1. Preparation:

- Choose a suitable location in soft soil or sand for installation. Ensure the area is clear of large stones or debris.

### 2. Position the Post:

- Place the post in the desired location. Ensure that the stabilizer arms are positioned firmly on the surface.
- Use a level to ensure the post is vertically aligned.

### 3. Screw-in Method:

- Attach your lighting fixture to the post using the 1/2" threaded hole. This is compatible with standard spotlights and lawn lights.
- Screw the fixture tightly to secure it in place.

### 4. Stabilization (Optional for Added Strength):

- For additional durability, especially in areas with loose soil, the post can be reinforced with concrete.
- Pour the concrete around the stabilizer arms and allow it to cure.



YOUTUBE VIDEO  
INSTALLATION GUIDE



WEBSITE

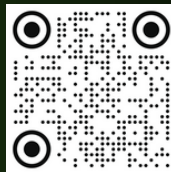

CATALOG

# ABBA

LIGHTING USA

12V Landscape Light Specialist

# INSTRUCTION MANUAL FOR PV51 INSTALLATION

## 5. Finishing:

- Once installed, ensure the fixture is stable and properly aligned.
- Adjust the lighting direction if necessary.

## CARE AND MAINTENANCE

- Periodically check the stability of the post and the fixture.
- Clean the post with mild soap and water to maintain its finish.
- Inspect the ground around the post to ensure that soil erosion has not compromised its stability.

## SAFETY INSTRUCTIONS

- Always wear protective gloves during installation.
- Ensure the power to the lighting fixture is off before handling any electrical connections.
- Follow local guidelines for outdoor lighting installation.



YOUTUBE VIDEO  
INSTALLATION GUIDE



WEBSITE

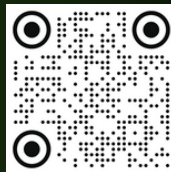

CATALOG

# ABBA

LIGHTING USA

*12V Landscape Light Specialist*

# INSTRUCTION MANUAL FOR PV51 INSTALLATION

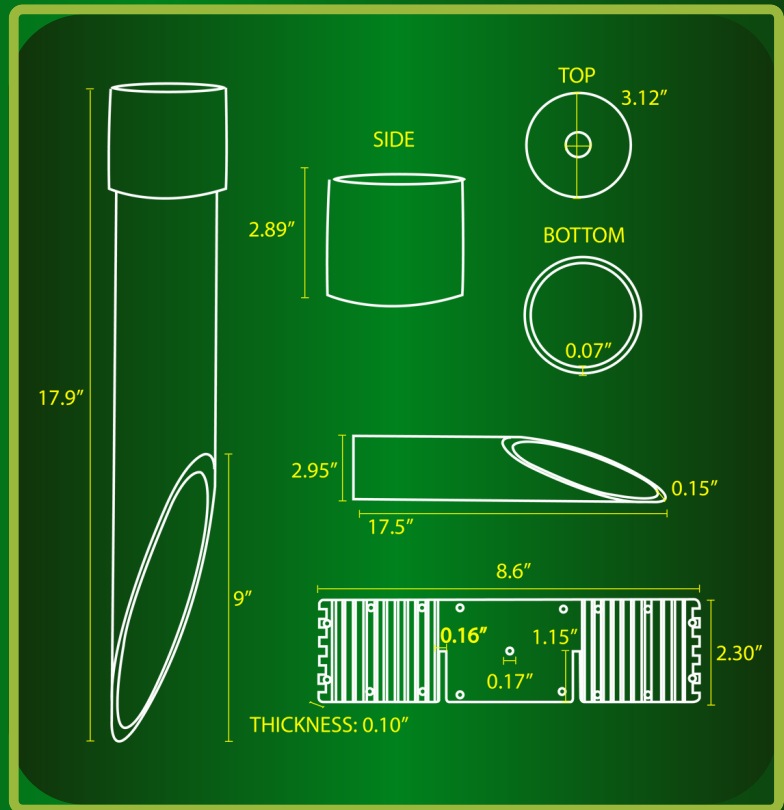

YOUTUBE VIDEO  
INSTALLATION GUIDE



WEBSITE

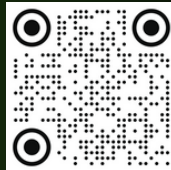

CATALOG

# ABBA

LIGHTING USA

12V Landscape Light Specialist



# INSTRUCTION MANUAL FOR PV51 INSTALLATION

## ADDITIONAL RESOURCES

For a detailed video tutorial on how to install the **PV51**, visit our YouTube channel and search for "**PV51**"

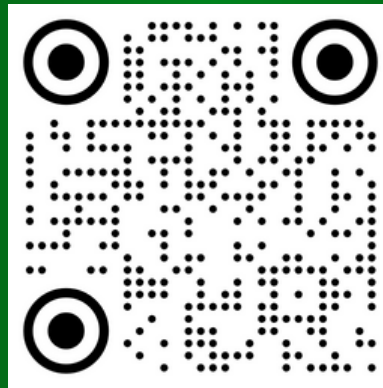

Please visit our website for more of our products.

[www.ABBALightingUSA.com](http://www.ABBALightingUSA.com)

For further assistance, please refer to our customer support team.  
(800) 360-2960

Enjoy your new lighting setup

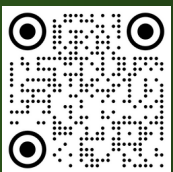

YOUTUBE VIDEO  
INSTALLATION GUIDE



WEBSITE

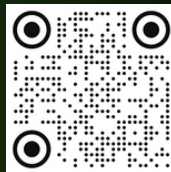

CATALOG

# ABBA

LIGHTING USA

*12V Landscape Light Specialist*