

# CDPSR59

## RGBCW SPOTLIGHT

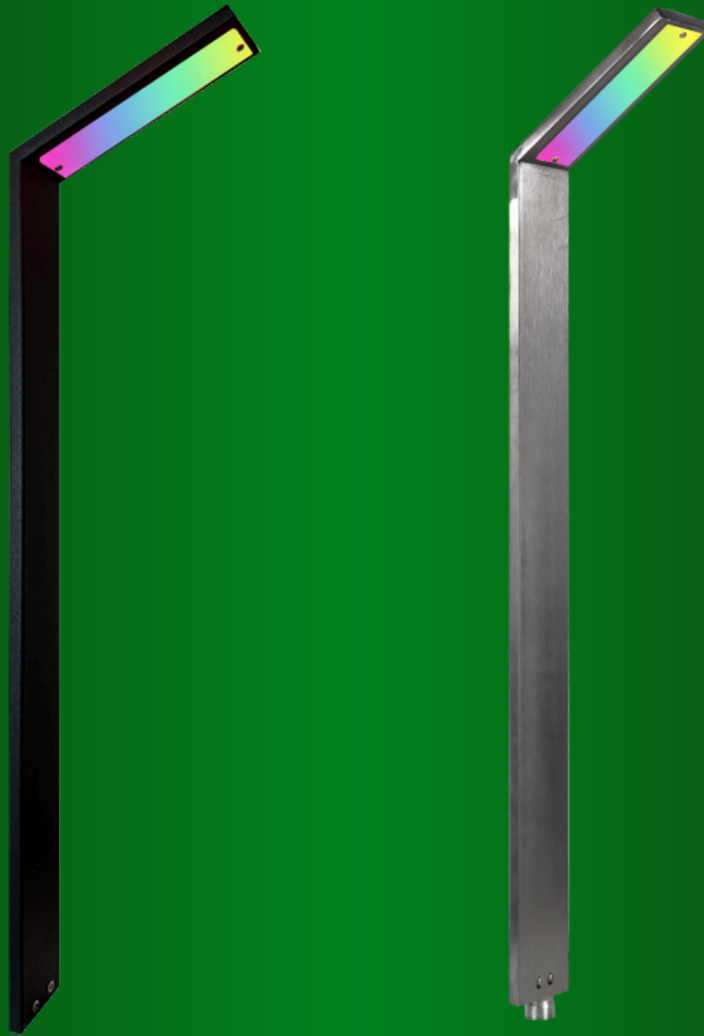

# INSTALLATION GUIDE



CDPSR59

(800) 360-2960  
7701 Alabama Ave.,  
Canoga Park CA, 91335  
[www.ABBALightingUSA.com](http://www.ABBALightingUSA.com)

# ABBA

**LIGHTING USA**

*12V Landscape Light Specialist*

**Congratulations on your purchase of this high-quality product! We want to ensure that you have the best possible experience with it, so we kindly ask that you take a moment to carefully read and follow all instructions before assembly, installation, and use. By doing so, you'll not only guarantee correct function and safety, but also optimize the full potential of this exceptional product. Thank you for choosing us as your trusted provider of top-notch products we truly appreciate your business!**



**YOUTUBE VIDEO  
INSTALLATION GUIDE**



**WEBSITE**

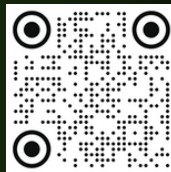

**CATALOG**

# ABBA

**LIGHTING USA**

*12V Landscape Light Specialist*

# WARNING:

## IMPORTANT SAFETY INSTRUCTIONS

### LIGHTEN LAMP IS HOT!

#### WARNING: TO REDUCE THE RISK OF FIRE OR INJURY TO PERSONS:

- ✓ Please exercise caution when using the lamp, as it tends to HEAT up rapidly. We recommend taking necessary safety measures to ensure optimal usage.
- ✓ For your safety, please refrain from touching the HOT lens, guard, or enclosure. We recommend waiting for the product to cool down before handling it.
- ✓ To prevent any fire hazards, please ensure that the lamp is kept away from materials that may easily catch fire. We appreciate your cooperation in maintaining a safe and secure environment.
- ✓ For safety reasons, we recommend that only a qualified professional install this electrical product.
- ✓ Before attempting to install this unit, ensure all power connections are off for your own safety.

## WARRANTY

- We stand behind the quality of our product and offer a 2 warranty. Kindly ensure that you keep the proof of purchase as it will be required for any warranty claims.
- Warranty will be void if there is any damage due to improper usage or modification to the fixture.
- Failure to comply with the instruction in this manual may increase the risk of damage or injury and will void warranty.



YOUTUBE VIDEO  
INSTALLATION GUIDE



WEBSITE

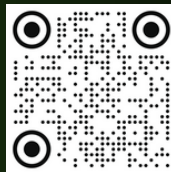

CATALOG

# ABBA

LIGHTING USA

12V Landscape Light Specialist

## CAUTION:

**FIXTURE(S) MUST BE INSTALLED IN ACCORDANCE WITH ALL LOCAL CODES AND ORDINANCES.**

**DO NOT INSTALL WITHIN 10 FEET OF A POOL, SPA OR FOUNTAIN**

### PRODUCT OVERVIEW

The CDPS59 Stainless Steel Path Light is designed to enhance outdoor landscapes, providing both functionality and style. Constructed from high-quality stainless steel, this durable fixture is ideal for illuminating walkways, gardens, and other outdoor spaces.

### TOOLS & MATERIALS NEEDED

#### Tools:

- Shovel or trowel
- Wire stripper (if hardwired)
- Screwdriver
- Tape measure

#### Materials:

- CDPS59 Stainless Steel Path Light
- Ground stake (included)
- Electrical connectors (for hardwiring)
- Low-voltage transformer (for low-voltage systems)
- WN12 Wire nuts (Sold Separately)



YOUTUBE VIDEO  
INSTALLATION GUIDE



WEBSITE

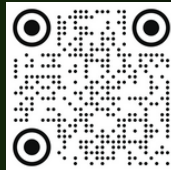

CATALOG

# ABBA

LIGHTING USA

*12V Landscape Light Specialist*

# INSTRUCTION MANUAL FOR CDPSR59 INSTALLATION

## STEP-BY-STEP INSTALLATION INSTRUCTIONS

### Step 1: Plan Your Layout

- **Determine Placement:** Choose the path or area where the lights will be installed. Measure the distance between lights to ensure even illumination. A typical spacing is 6–10 feet apart, depending on the desired light spread.
- **Consider Power Source:** Ensure that the path light can be connected to a suitable power source, whether it's a low-voltage transformer or another electrical source.

### Step 2: Prepare the Ground

- **Dig the Hole:** Using a shovel or trowel, dig a hole where you want to install the path light. The hole should be deep enough to accommodate the ground stake.
- **Ensure Stability:** Make sure the hole is wide enough to allow the ground stake to sit firmly. Test-fit the stake by inserting it into the hole to ensure stability before proceeding.

### Step 3: Connect the Electrical Wiring

- **For Low-Voltage Systems:**
- **Strip the Wires:** Use a wire stripper to strip ½ inch of insulation from the end of the light's wires.
- **Connect to the Transformer:** Attach the wires to the low-voltage transformer, . Ensure the positive and negative terminals are correctly aligned.



YOUTUBE VIDEO  
INSTALLATION GUIDE



WEBSITE

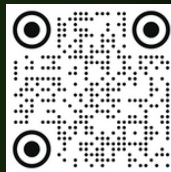

CATALOG

# ABBA

LIGHTING USA

12V Landscape Light Specialist

# INSTRUCTION MANUAL FOR CDPSR59 INSTALLATION

- **Waterproof the Connections:** Use WN12 waterproof wirenuts (Sold Separately) to protect the wiring from moisture and outdoor conditions when connecting the wires from the fixture.

## Step 4: Attach the Path Light

- **Mount the Fixture:** Once the wiring is complete, securely attach the CDPS58 path light to the ground stake.
- **Secure the Fixture:** Ensure the fixture is stable and upright. Adjust the positioning as needed before tightening the fixture in place.

## Step 6: Attach the Path Light

- **Power On:** Once everything is connected, turn on the power to the fixture.
- **Check Illumination:** Verify that the path light is functioning properly and provides adequate illumination for the area.
- **Adjust if Necessary:** If needed, reposition the fixture or adjust its height for optimal light coverage.

## Step 6: Pairing your phone with the app

- Begin by connecting your phone to a 2.4Ghz Wifi-Network.
- Install the TUYA SMART LIFE APP into your phone



YOUTUBE VIDEO  
INSTALLATION GUIDE



WEBSITE

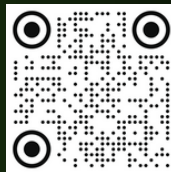

CATALOG

# ABBA

LIGHTING USA

*12V Landscape Light Specialist*

# INSTRUCTION MANUAL FOR CDPSR59 INSTALLATION



- After downloading your APP. Proceed to register your account using your mobile number. Expect a verification code via text message or email within a few minutes. Enter the code when prompted to establish your password.
- Open the app and carefully follow the instructions displayed on the screen.
- If the light doesn't flash when first turned on. reset it by toggling the power ON and OFF three times.
- Select "ADD DEVICE"

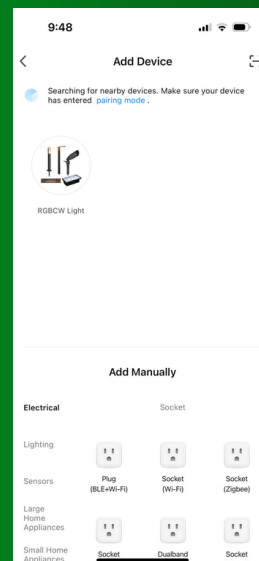
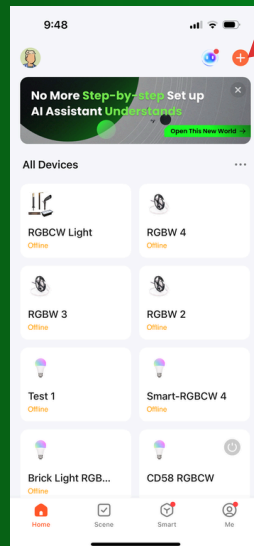

YOUTUBE VIDEO  
INSTALLATION GUIDE



WEBSITE

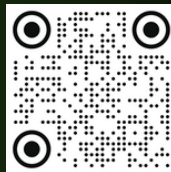

CATALOG

# ABBA

LIGHTING USA

12V Landscape Light Specialist

# INSTRUCTION MANUAL FOR CDPSR59 INSTALLATION

- Proceed by choosing your 2.4 Ghz WI-FI network and input the corresponding password
- Upon successful completion. You will receive a prompt confirming that the device has been successfully added.

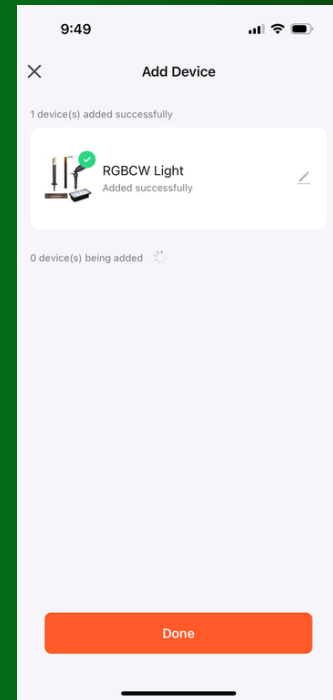
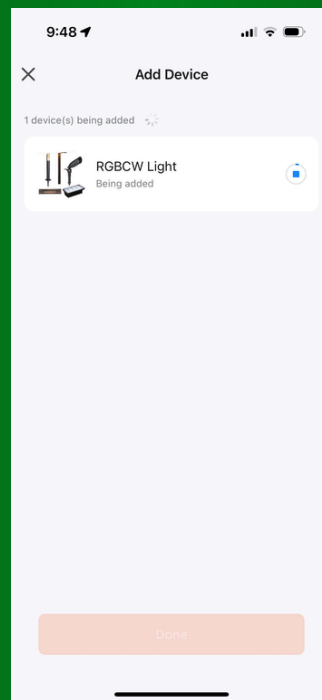
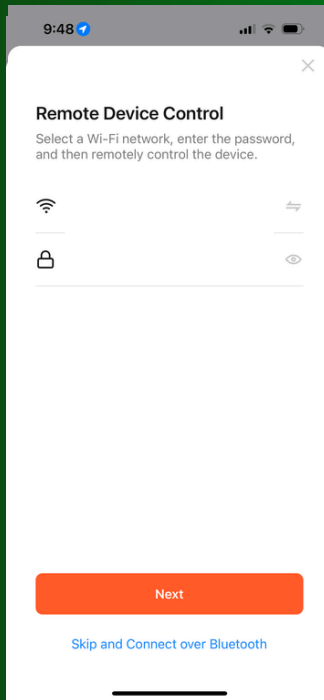

- Open the app to customize the lighting to your preference



YOUTUBE VIDEO  
INSTALLATION GUIDE



WEBSITE

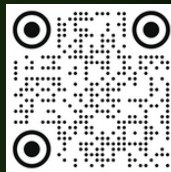

CATALOG

# ABBA

LIGHTING USA

12V Landscape Light Specialist



# INSTRUCTION MANUAL FOR CDPSR59 INSTALLATION

We strongly recommend that the main cable from the transformer be buried underground for safety reasons. Additionally, please be sure to avoid exceeding the maximum wattage on the fixture(s) to prevent any damage or hazards

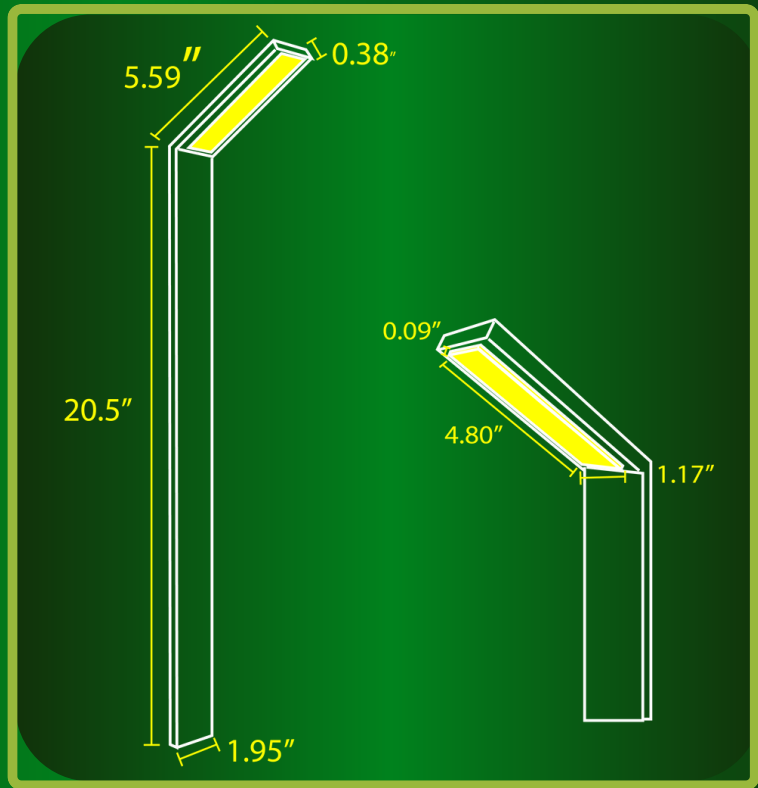

YOUTUBE VIDEO  
INSTALLATION GUIDE



WEBSITE

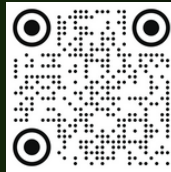

CATALOG

# ABBA

LIGHTING USA

12V Landscape Light Specialist

# INSTRUCTION MANUAL FOR CDPSR59 INSTALLATION

## MAINTENANCE TIPS

- **Regular Inspection:** Periodically check the bracket and fixture to ensure they are still securely mounted and functioning correctly.
- **Surface Maintenance:** Monitor the mounting surface, particularly trees, to ensure the bracket does not cause damage as the tree grows.

## SAFETY PRECAUTIONS

- Always wear appropriate safety gear, such as gloves and safety glasses, during installation.
- Ensure the mounting surface is capable of supporting the weight of both the bracket and the lighting fixture.

## ADDITIONAL RESOURCES

For a detailed video tutorial on how to install the **CDPSR59**, visit our YouTube channel and search for "**CDPSR59**"

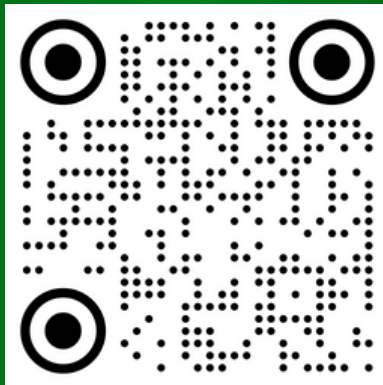

Please visit our website for more of our products.  
[www.ABBALightingUSA.com](http://www.ABBALightingUSA.com)

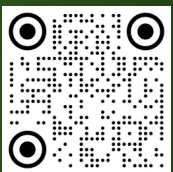

YOUTUBE VIDEO  
INSTALLATION GUIDE



WEBSITE

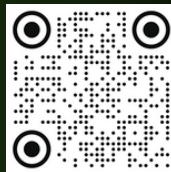

CATALOG

# ABBA

LIGHTING USA

*12V Landscape Light Specialist*